

input tape

0

0

0

1

0

1

state transition graph

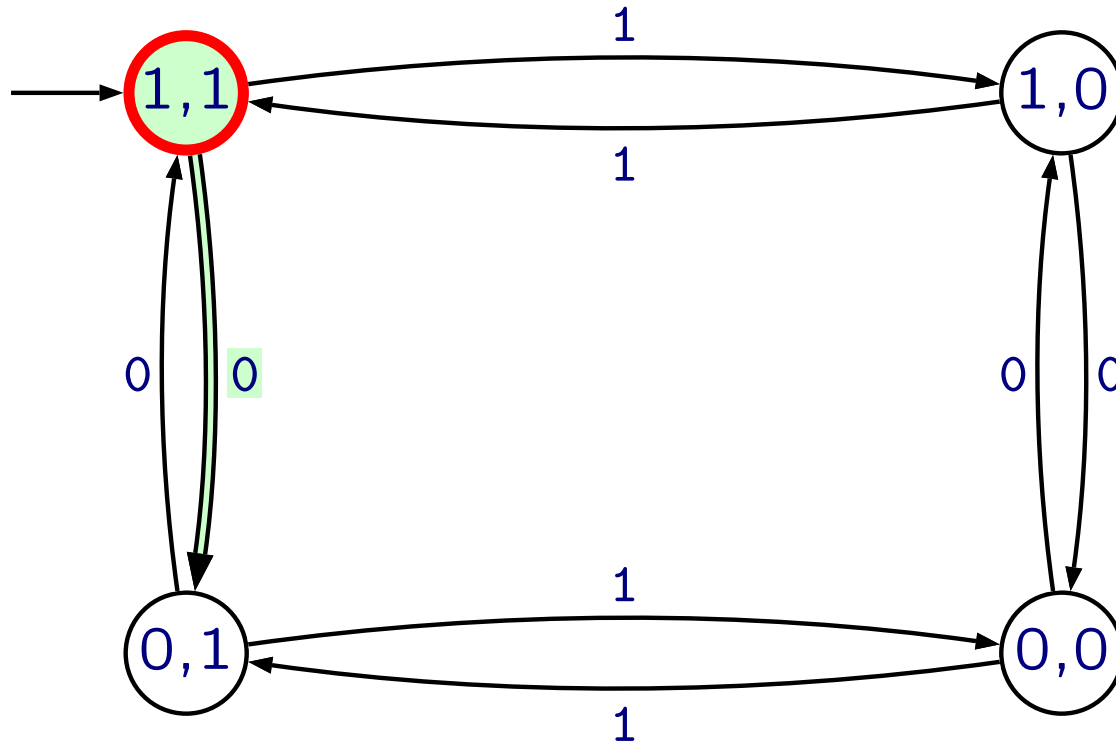

parity test



Akzeptieren

input tape

0

0

0

1

0

1

state transition graph

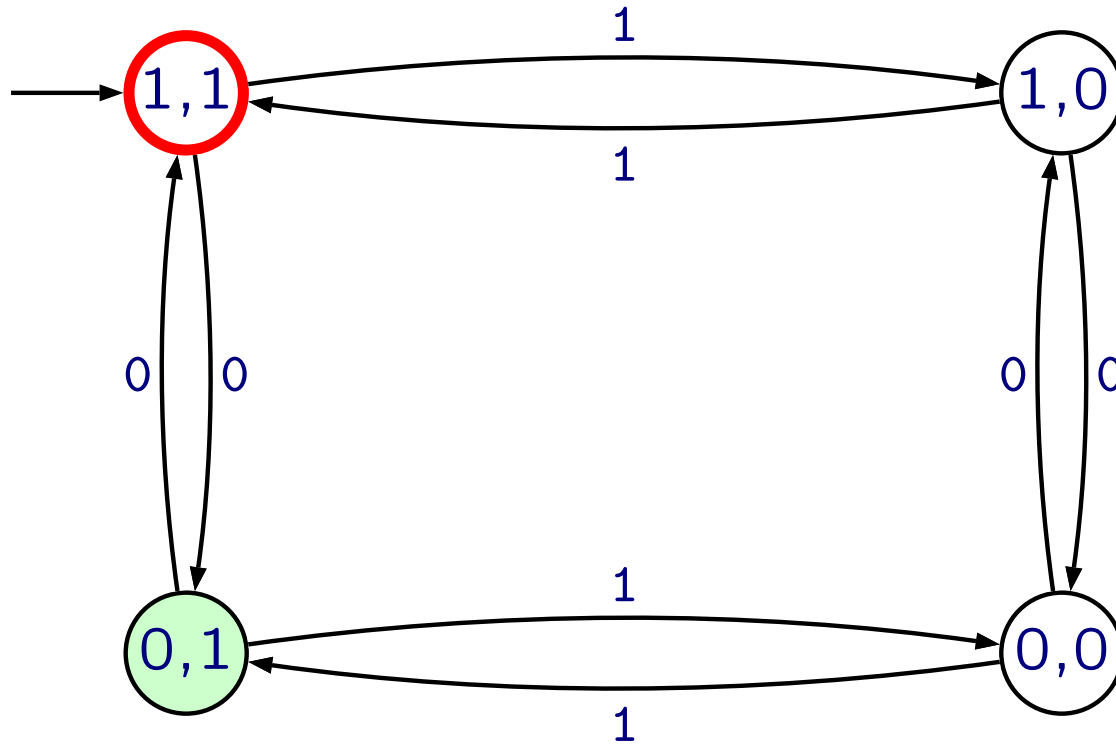

parity test



Akzeptieren

input tape

0

0

0

1

0

1

state transition graph

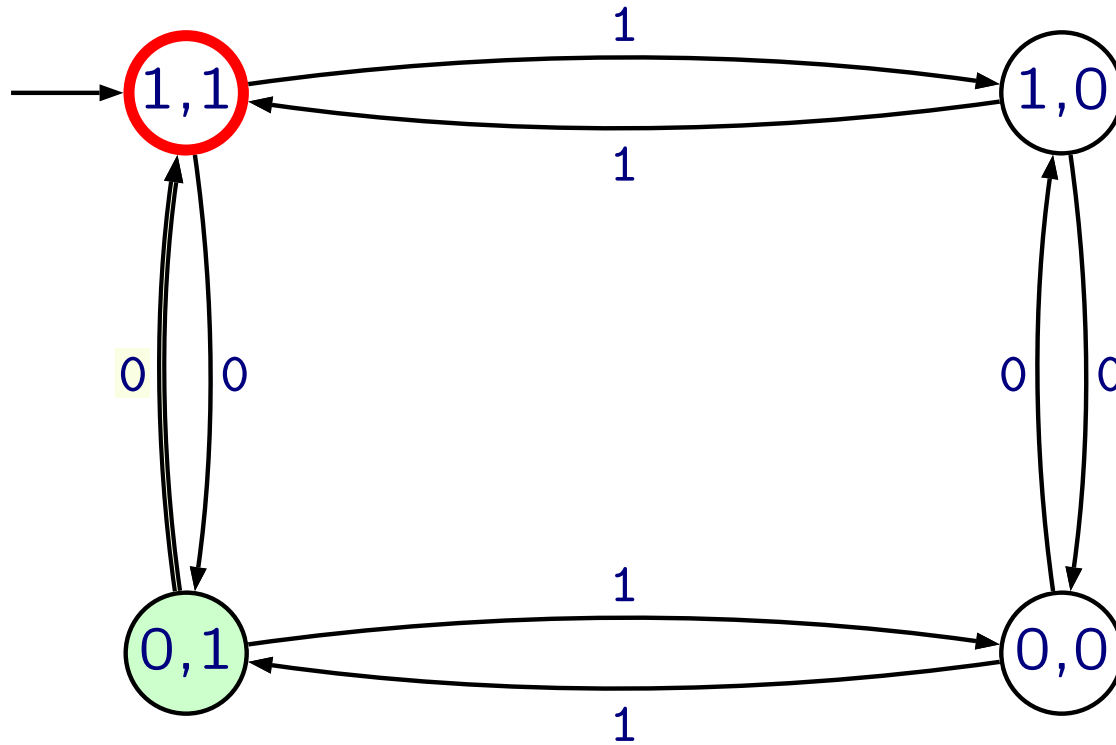

parity test



Akzeptieren

input tape

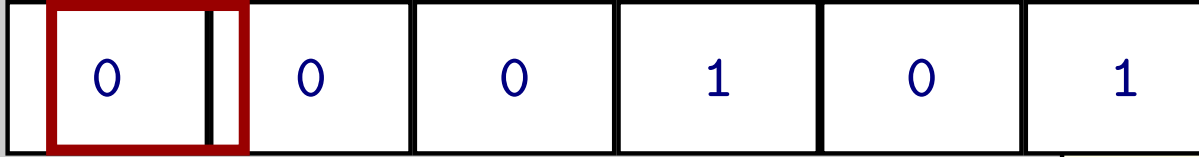

state transition graph

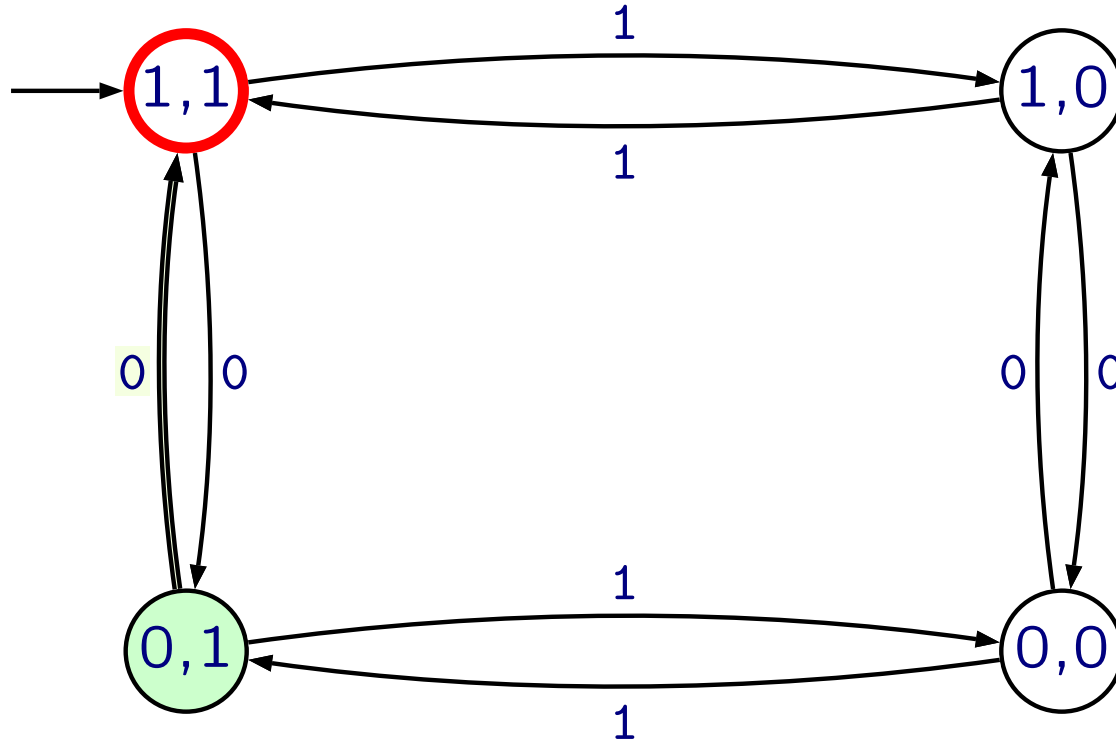

parity test



Akzeptieren

input tape



state transition graph

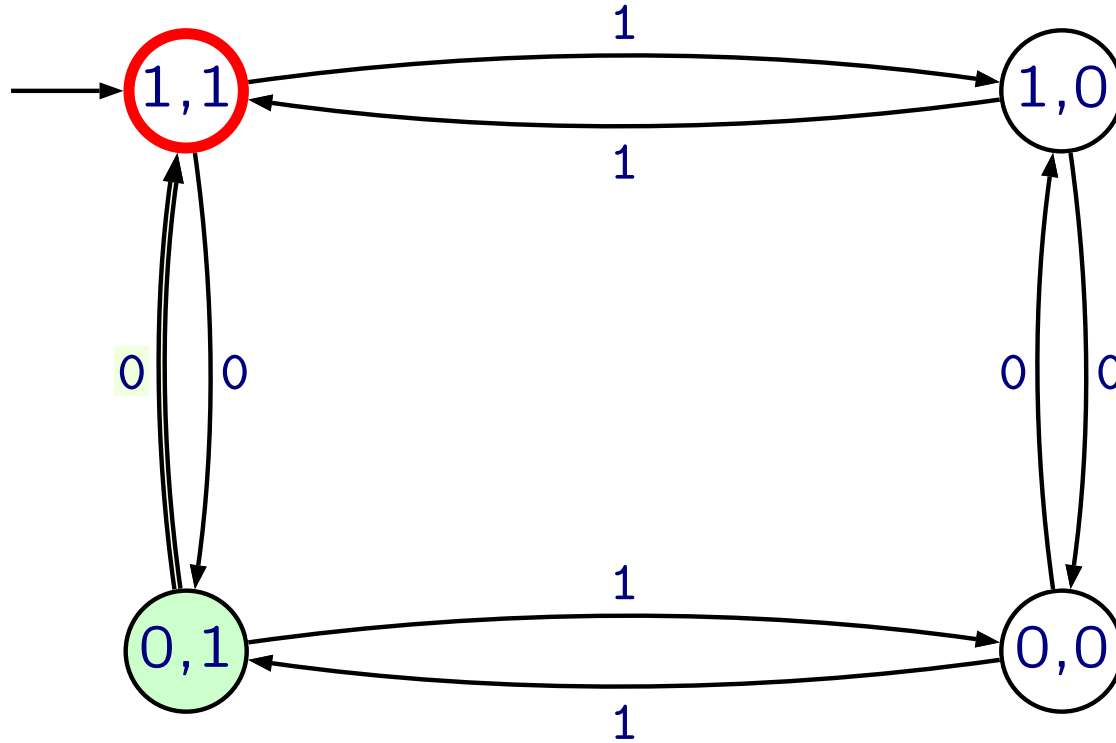

parity test



Akzeptieren

input tape

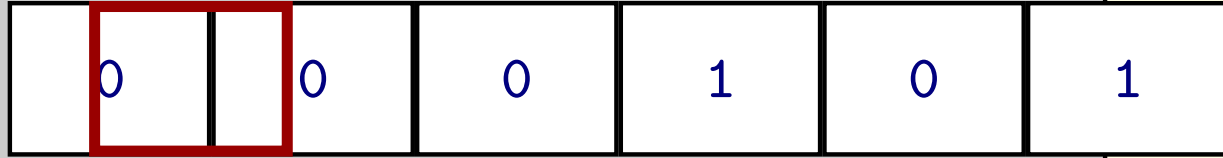

state transition graph

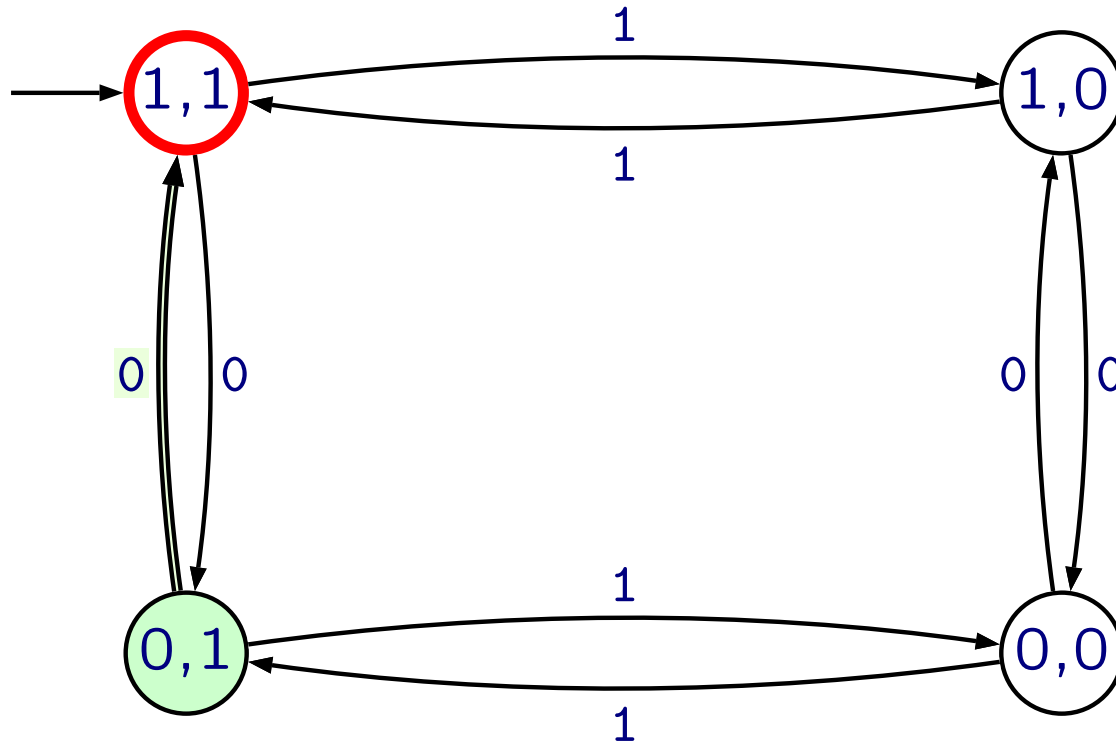

parity test



Akzeptieren

input tape



state transition graph

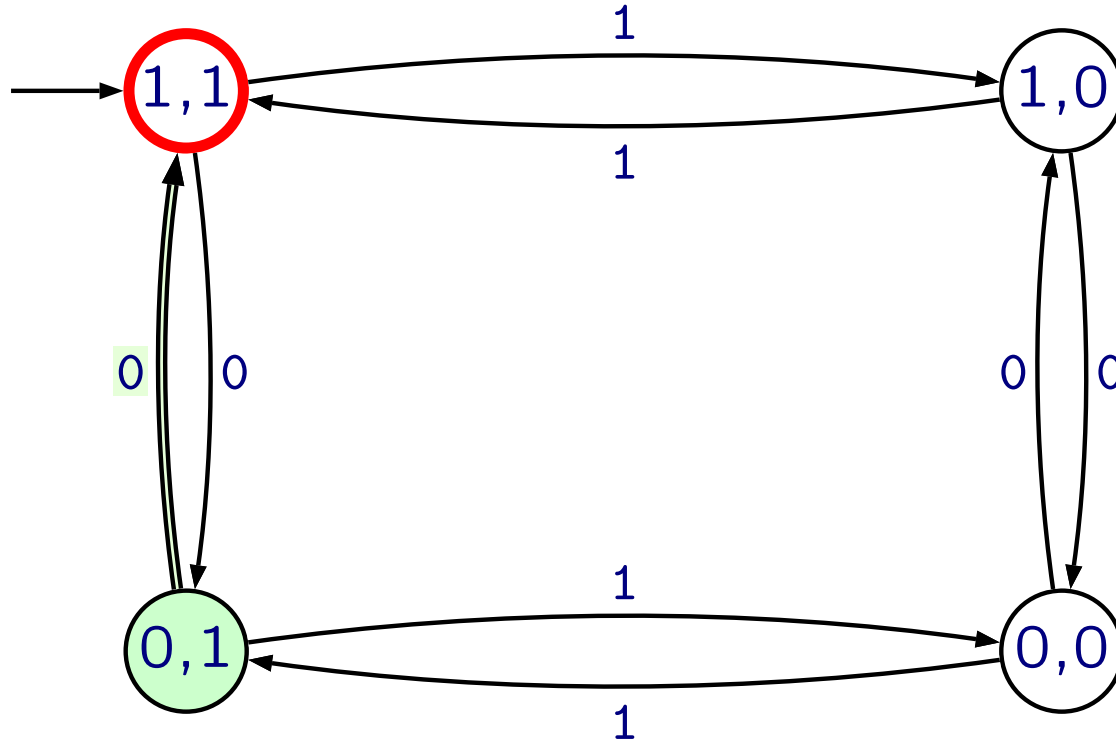

parity test



Akzeptieren

input tape

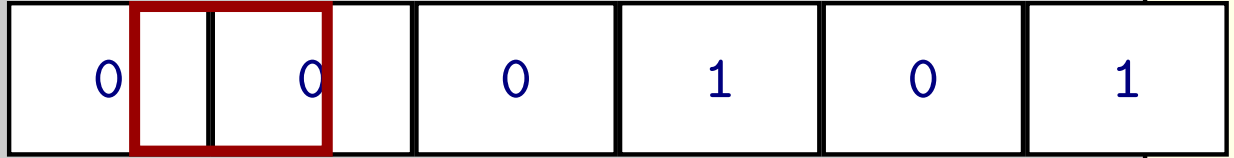

state transition graph

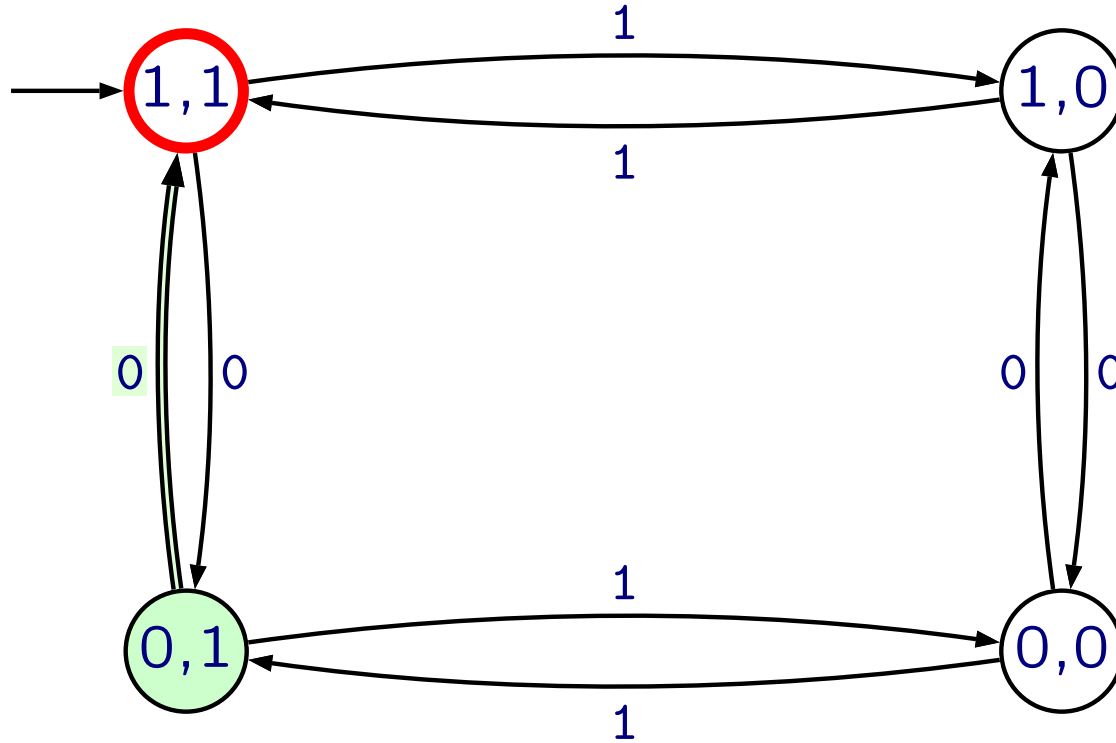

parity test



Akzeptieren

input tape

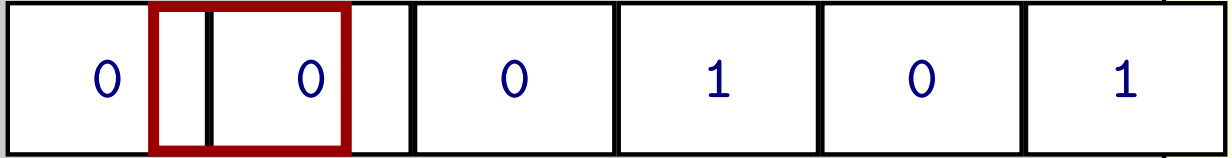

state transition graph

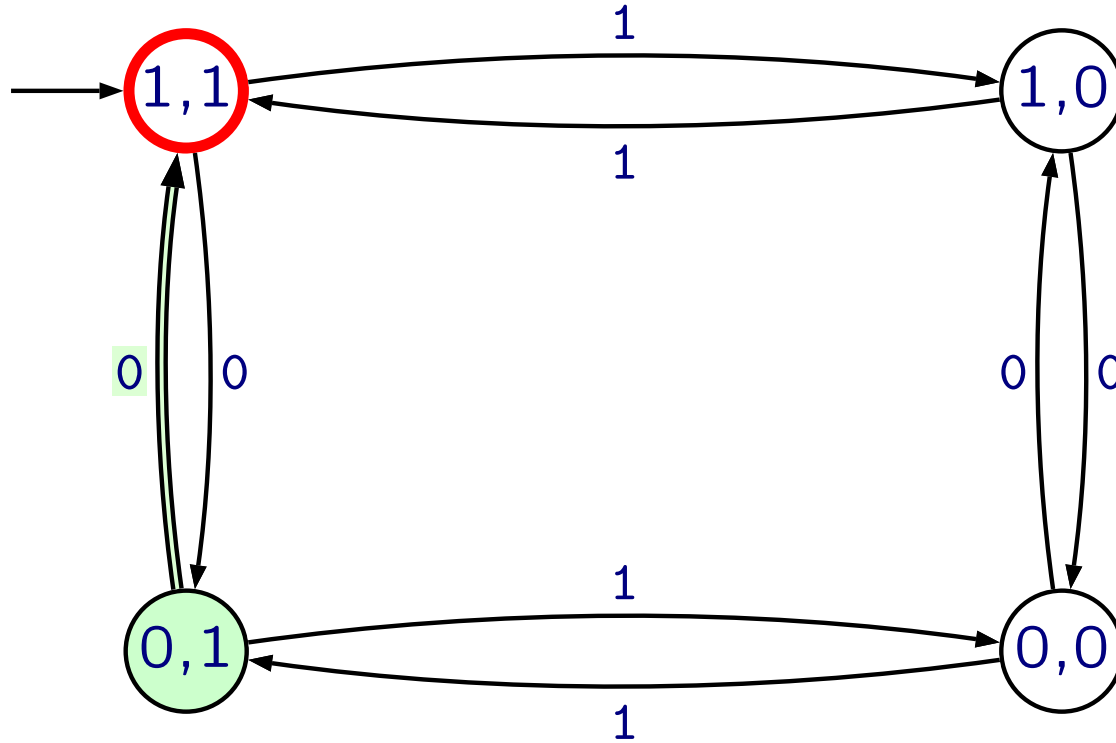

parity test



Akzeptieren

input tape

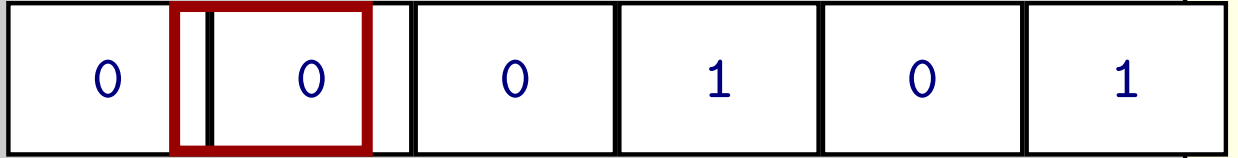

state transition graph

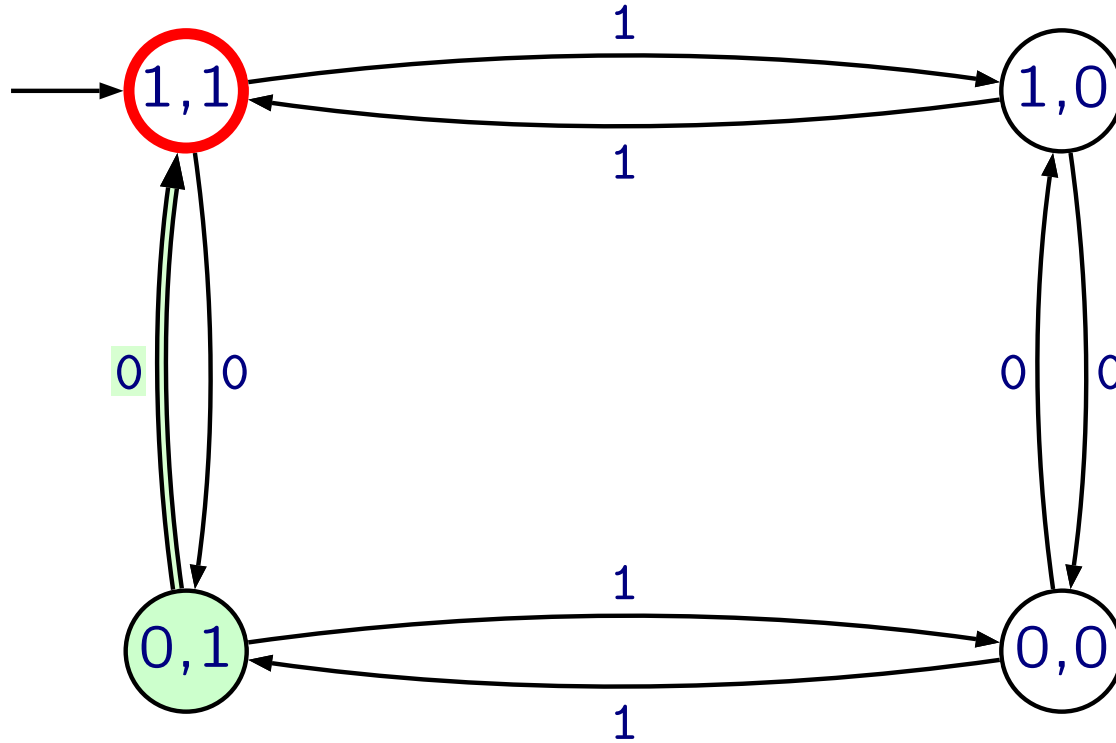

parity test



Akzeptieren

input tape

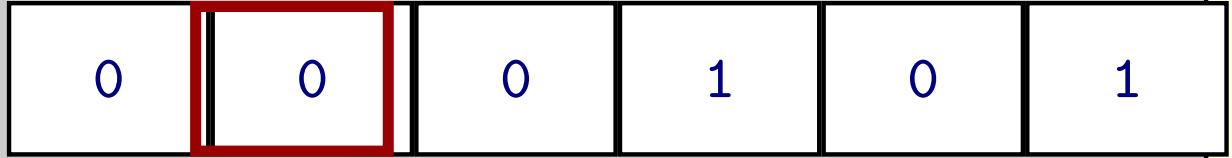

state transition graph

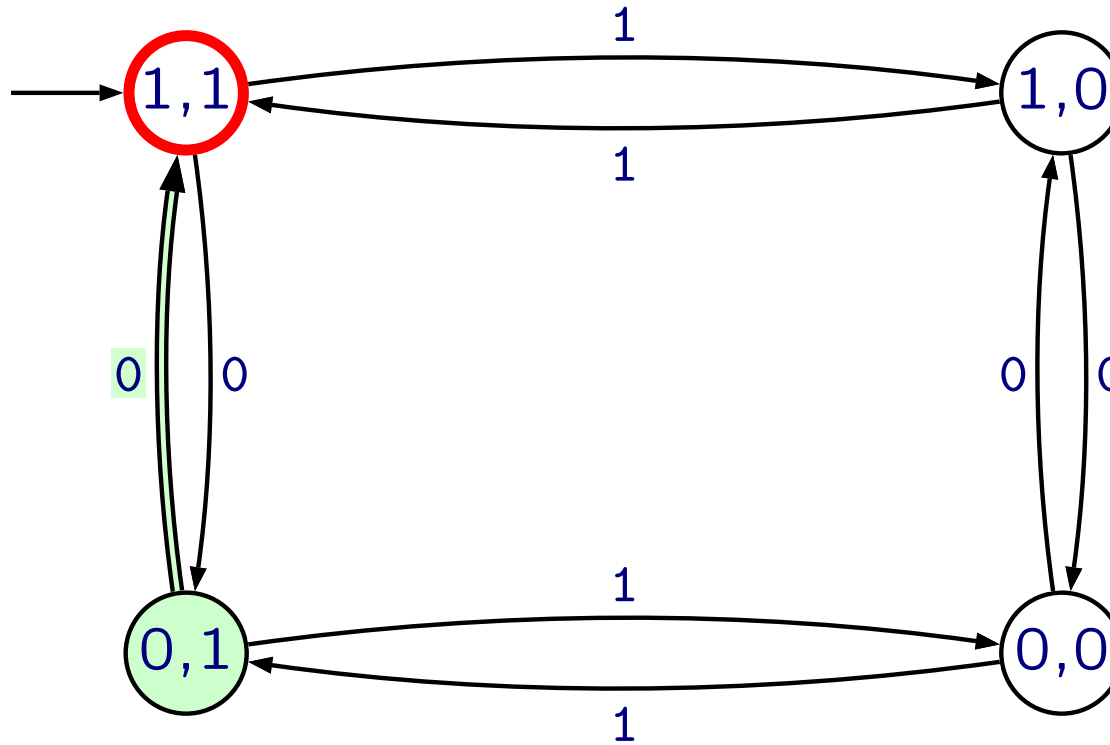

parity test



Akzeptieren

input tape

0

0

0

1

0

1

state transition graph

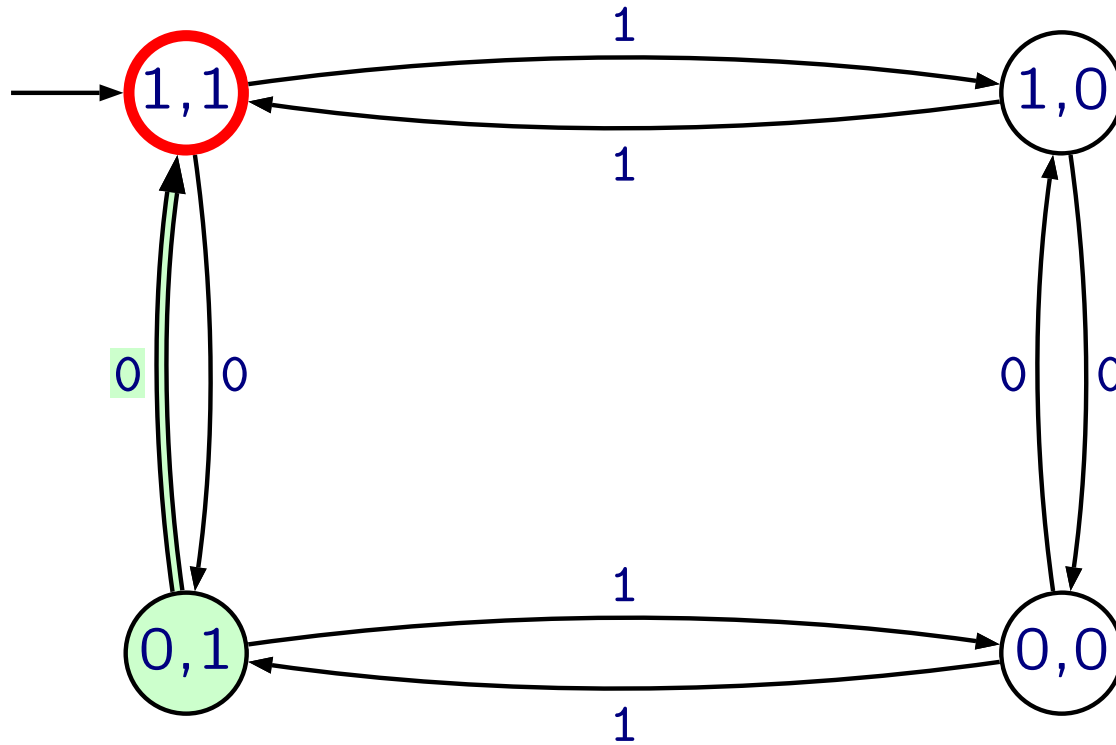

parity test



Akzeptieren

input tape

0

0

0

1

0

1

state transition graph

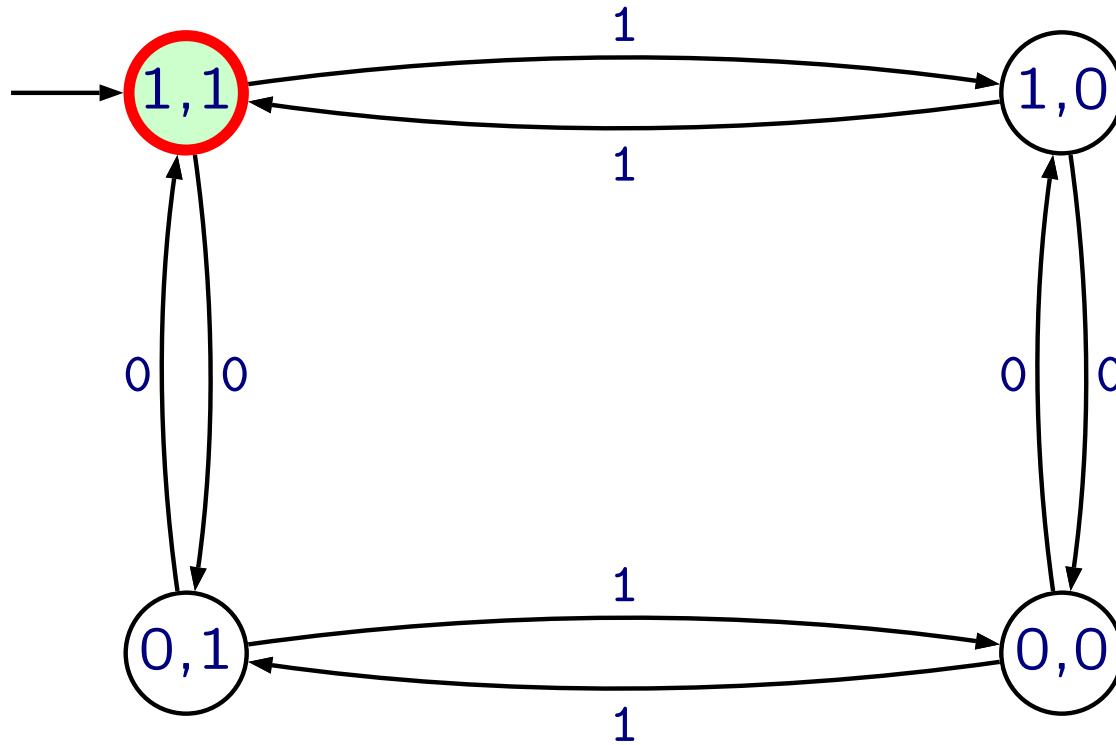

parity test



Akzeptieren

input tape

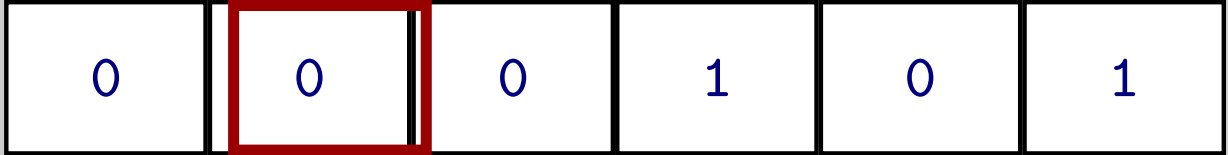

state transition graph

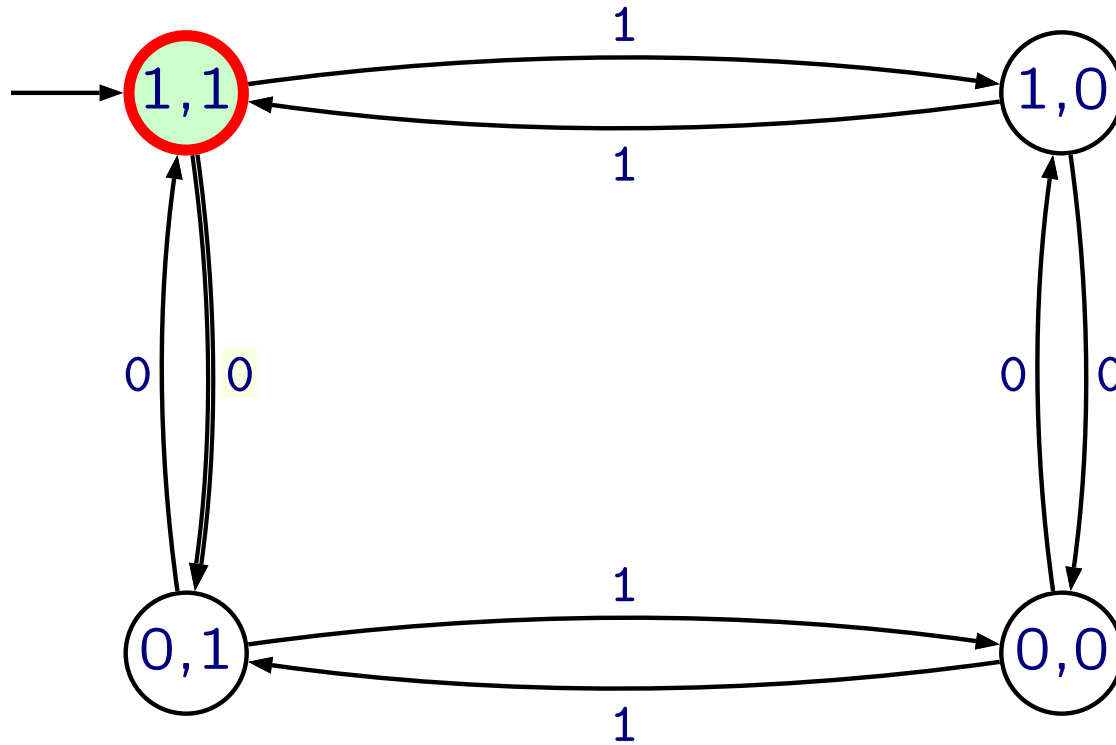

parity test



Akzeptieren

input tape



state transition graph

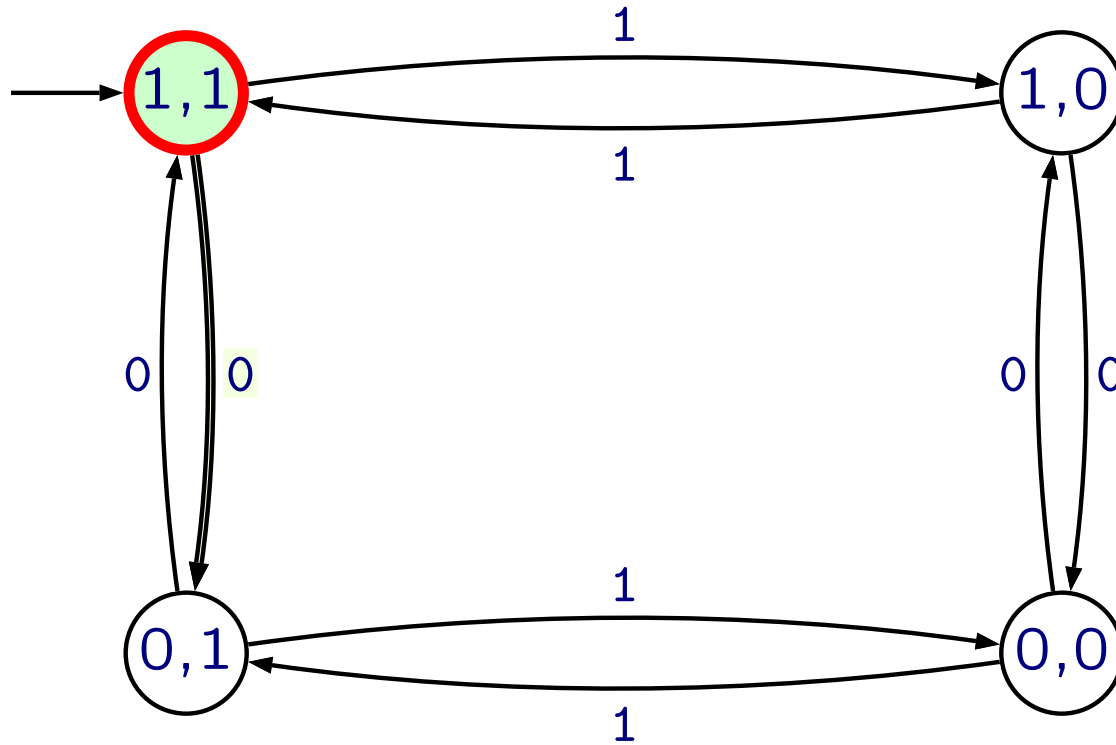

parity test



Akzeptieren

input tape



state transition graph

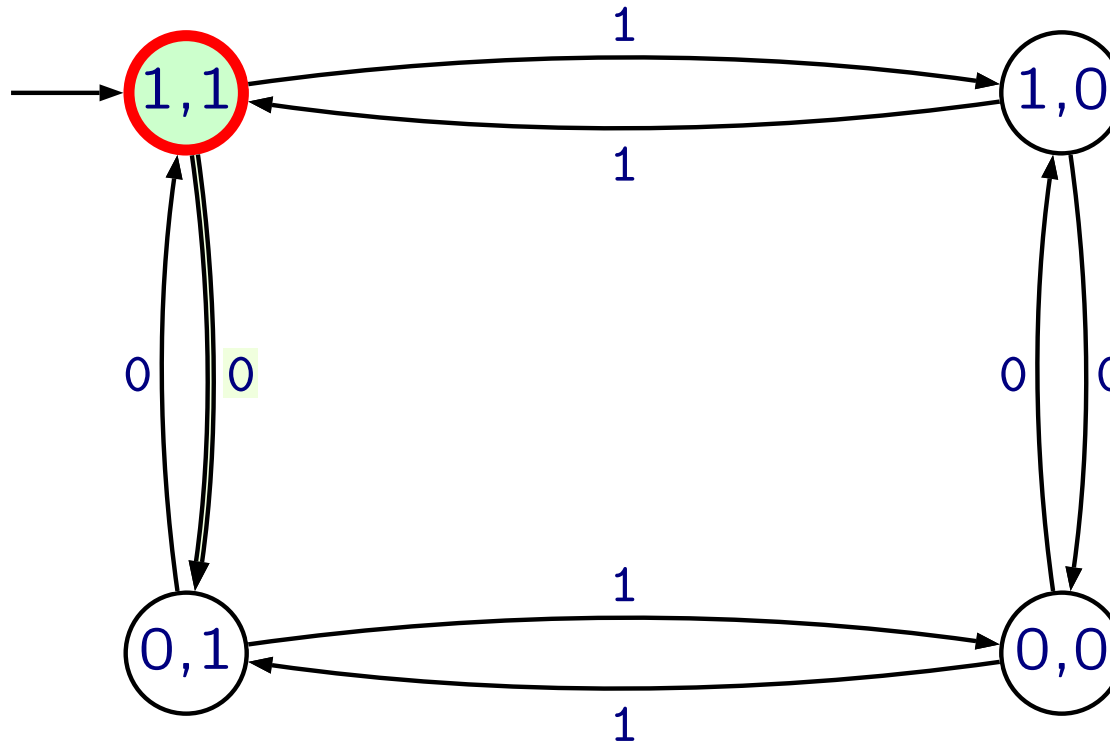

parity test



Akzeptieren

input tape

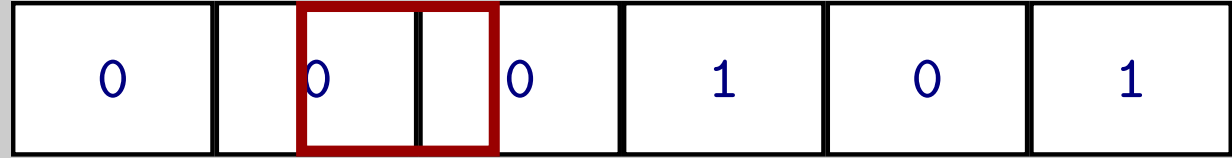

state transition graph

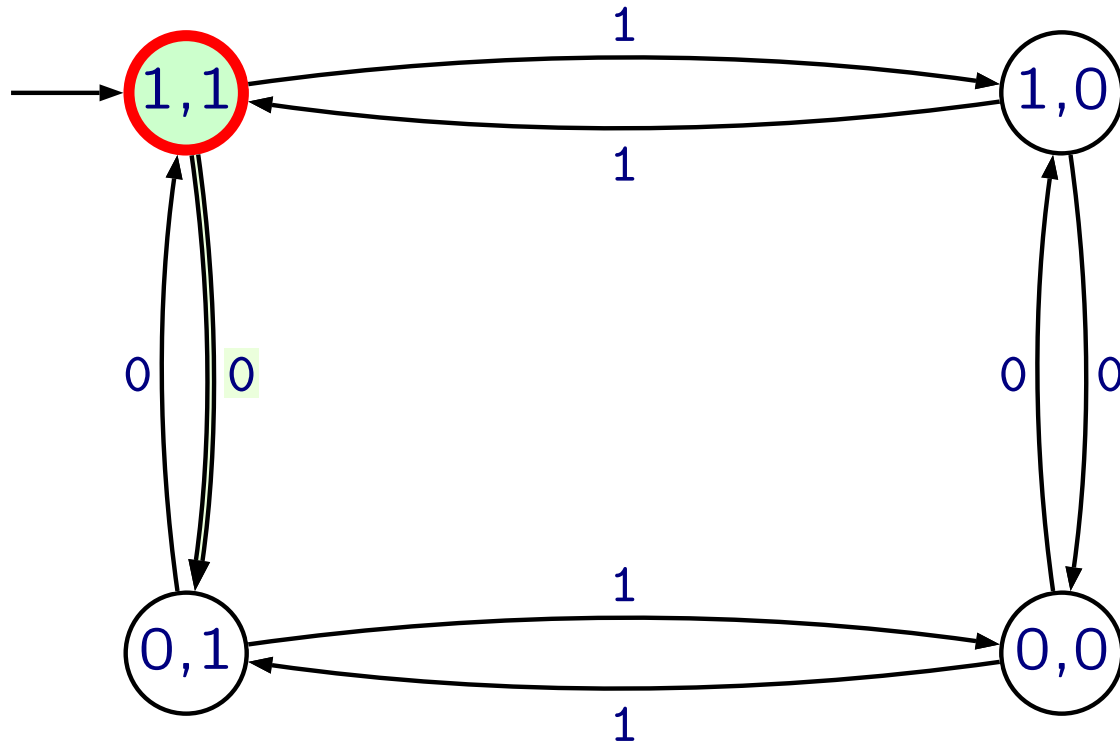

parity test



Akzeptieren

input tape

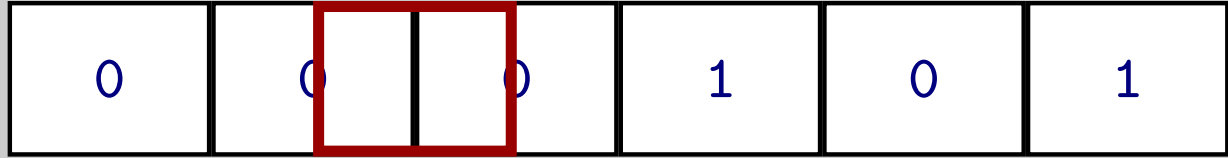

state transition graph

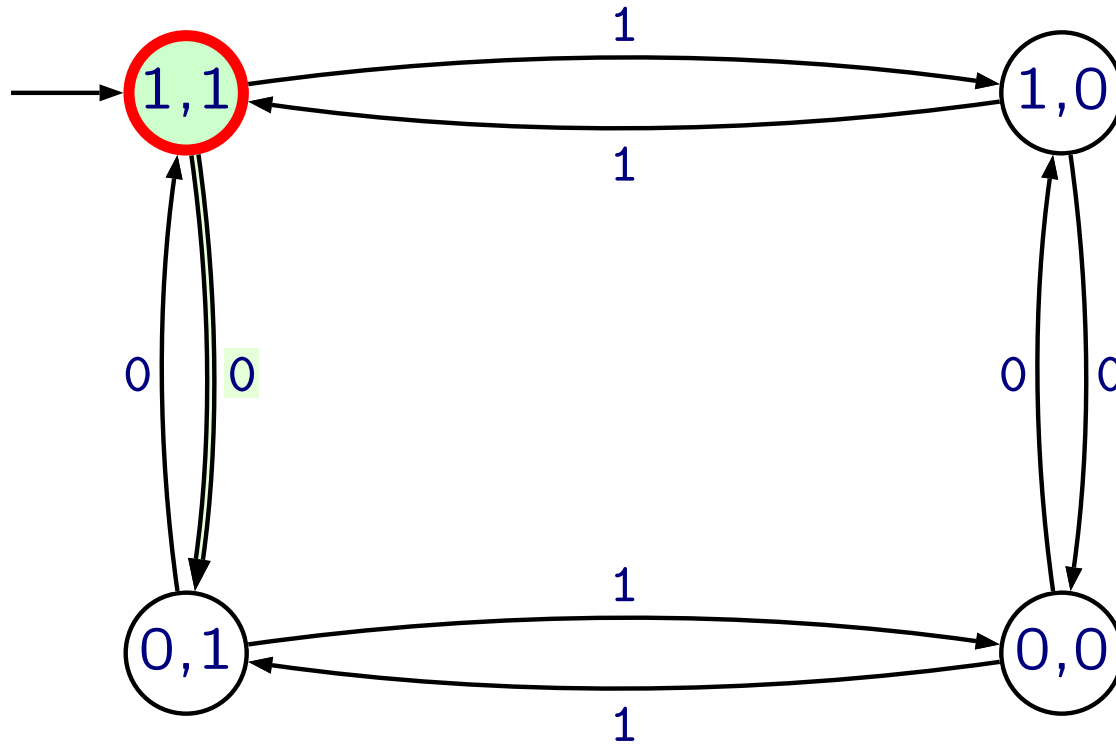

parity test



Akzeptieren

input tape

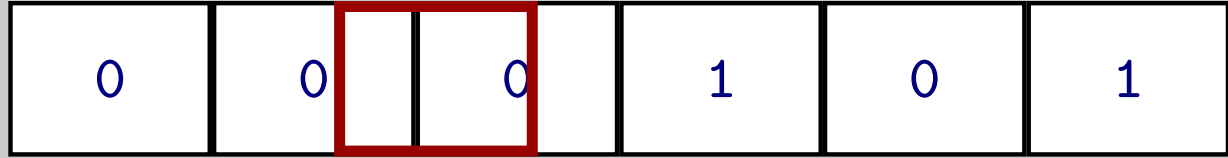

state transition graph

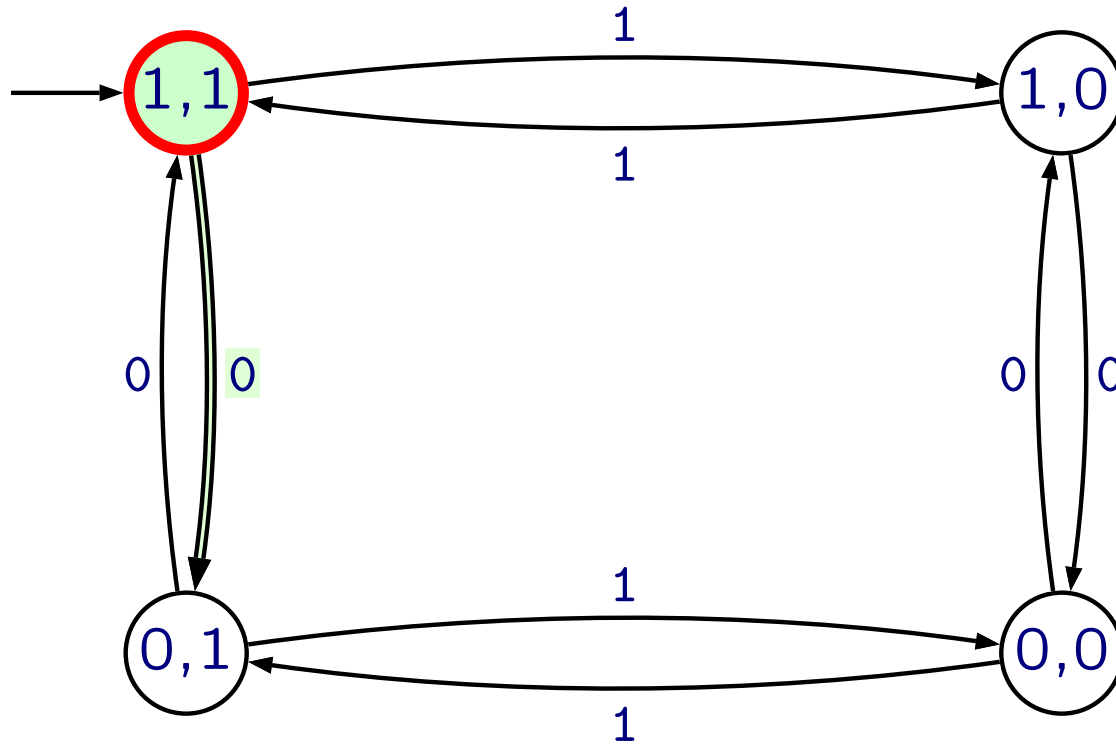

parity test



Akzeptieren

input tape



state transition graph

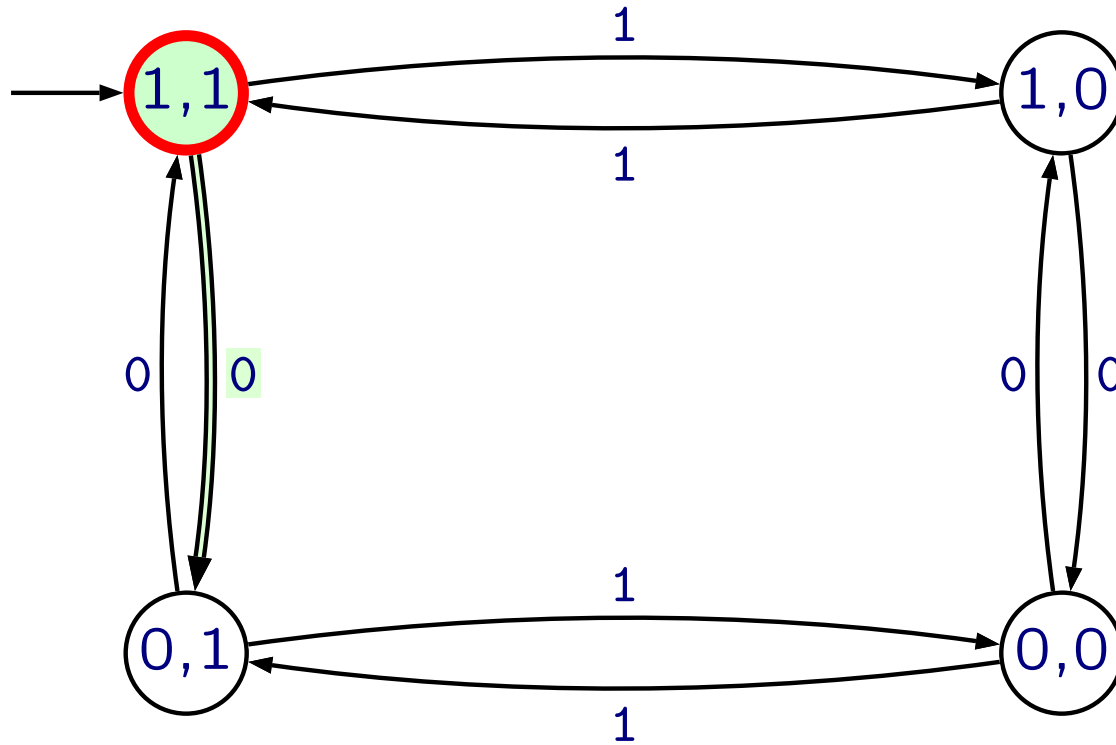

parity test



Akzeptieren

input tape

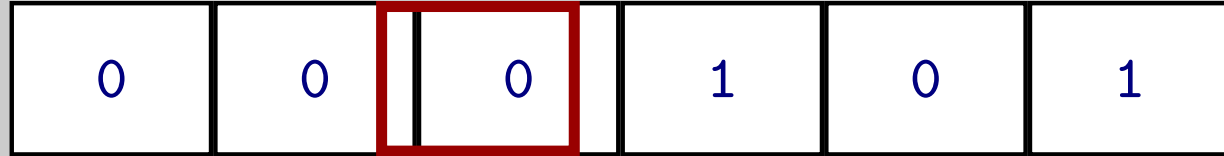

state transition graph

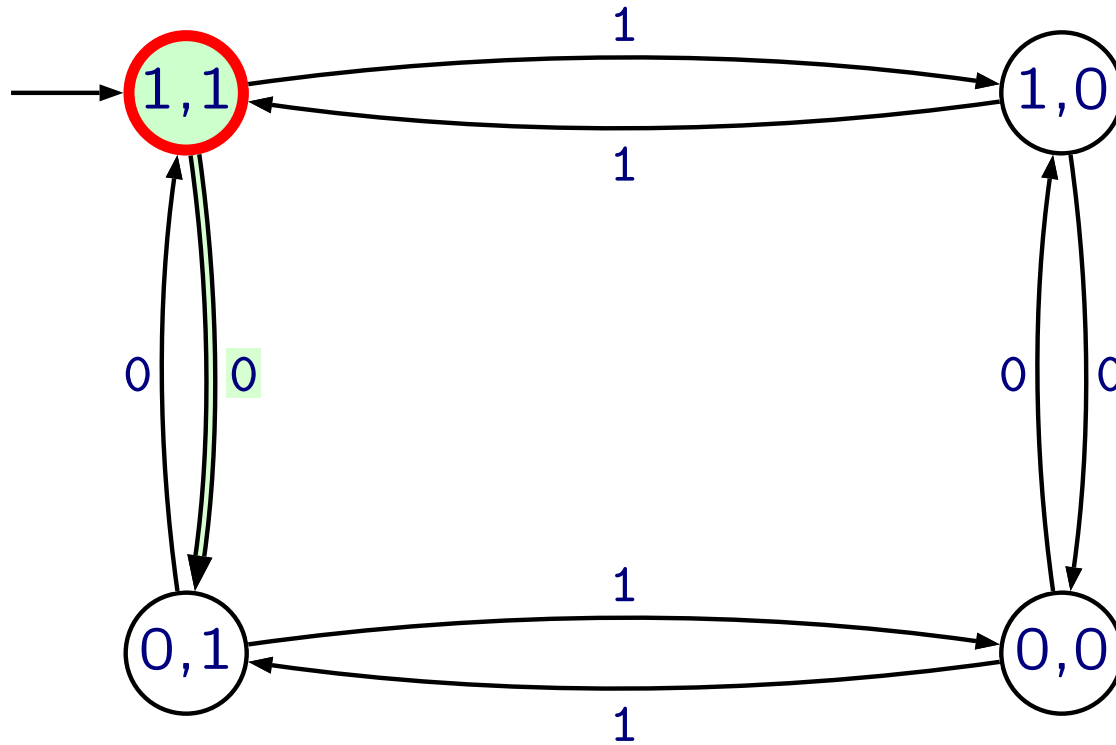

parity test



Akzeptieren

input tape



state transition graph

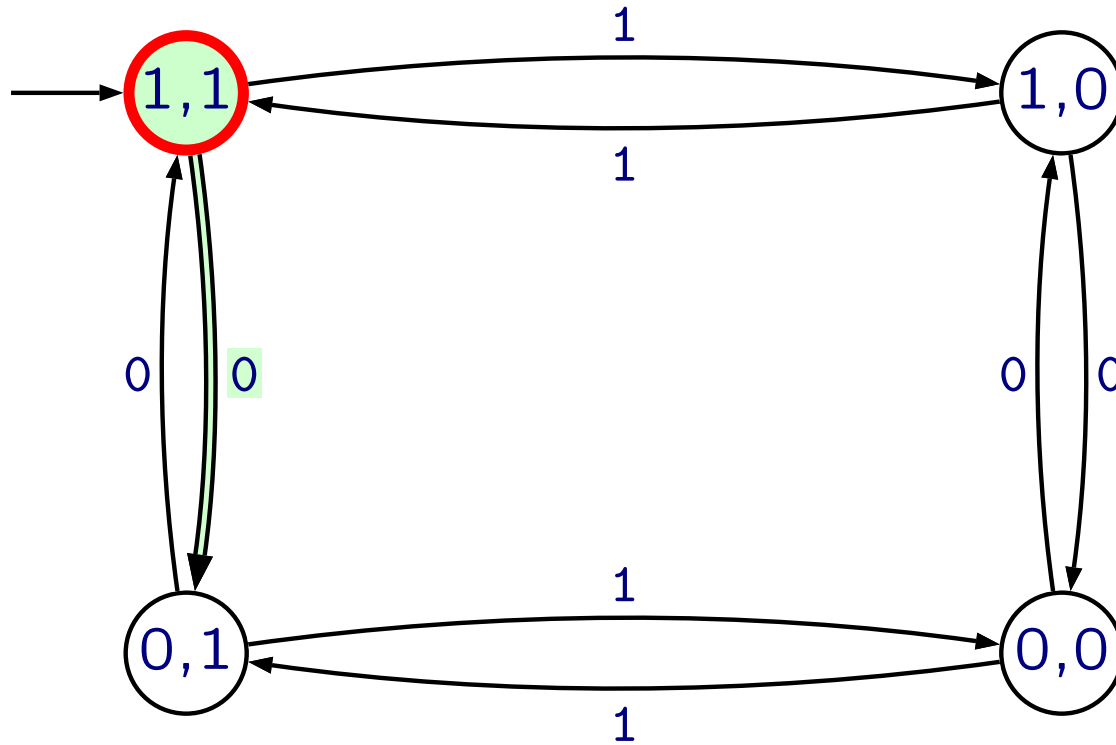

parity test



Akzeptieren

input tape

0

0

0

1

0

1

state transition graph

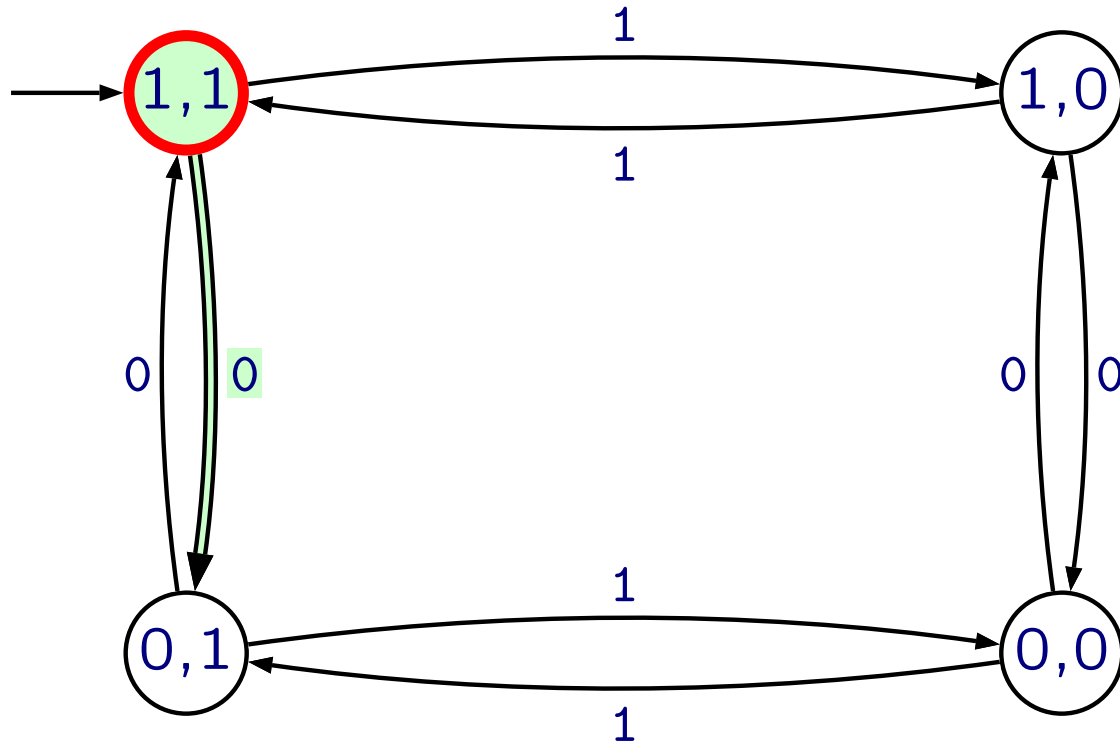

parity test



Akzeptieren

input tape

0

0

0

1

0

1

state transition graph

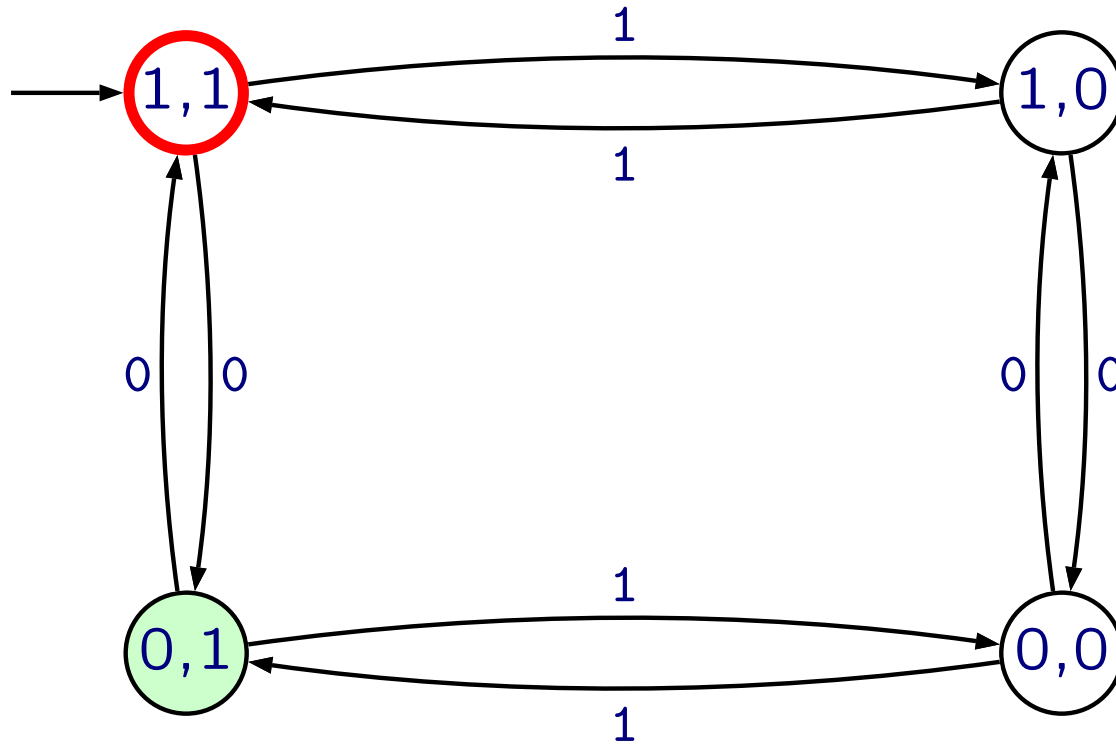

parity test



Akzeptieren

input tape

0

0

0

1

0

1

state transition graph

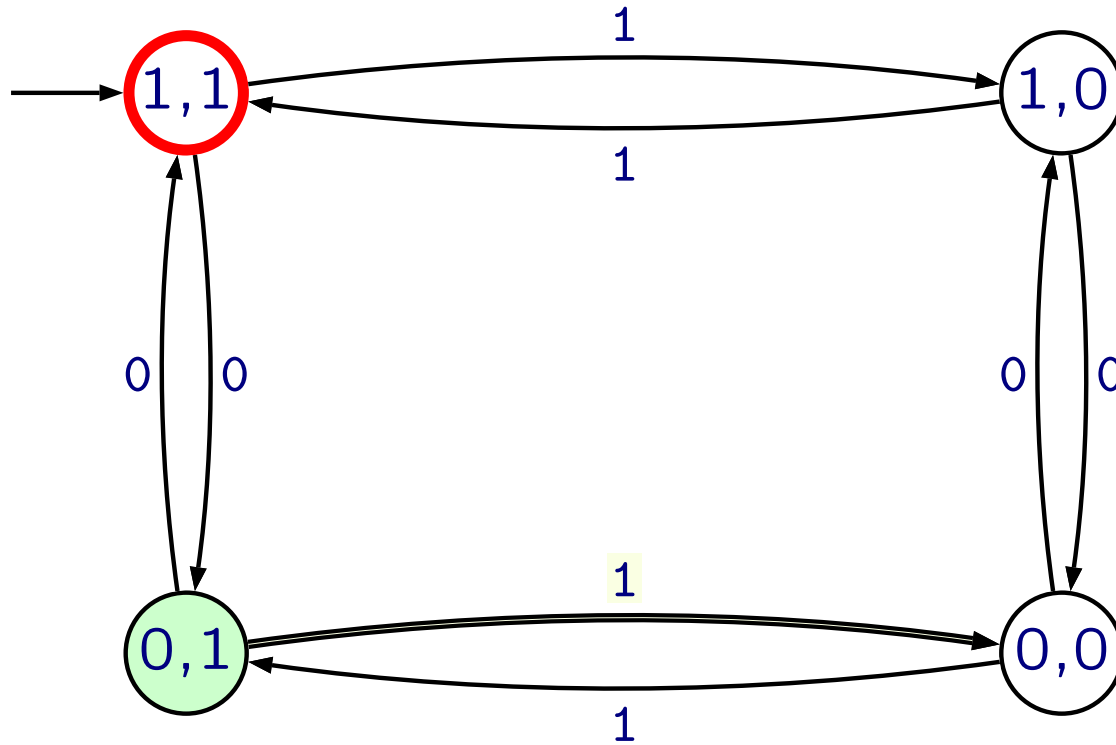

parity test



Akzeptieren

input tape

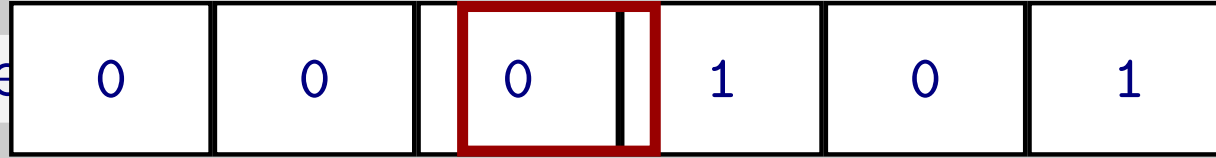

state transition graph

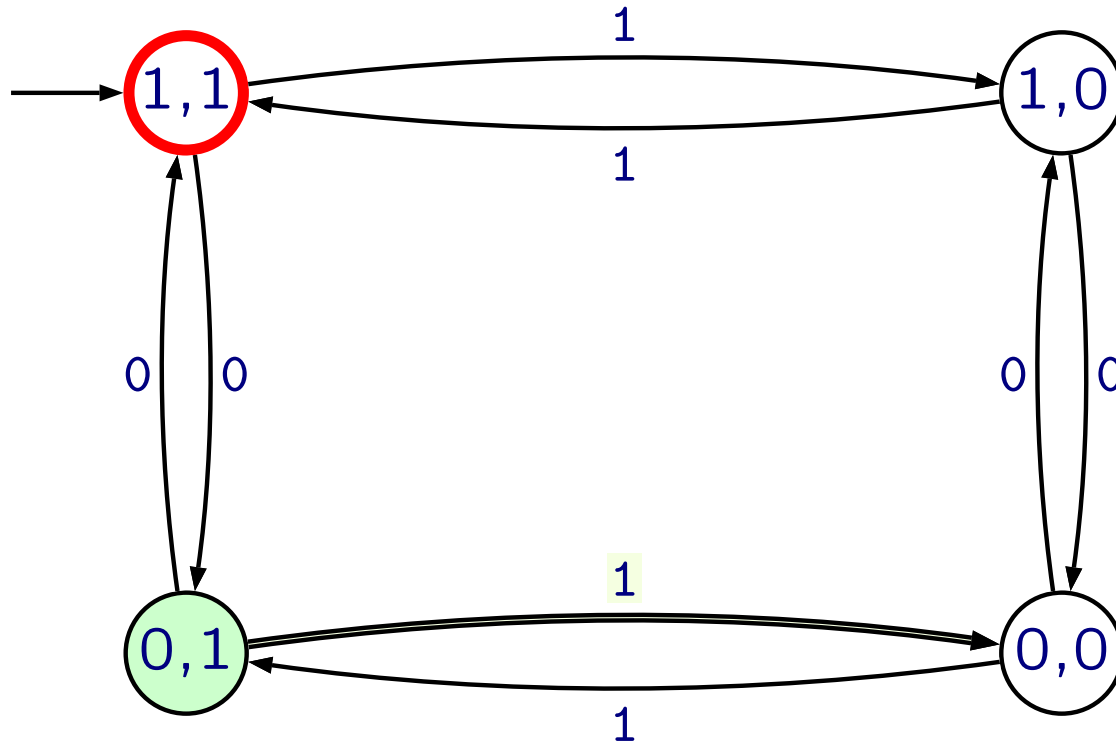

parity test



Akzeptieren

input tap

0

0

0

1

0

1

state transition graph

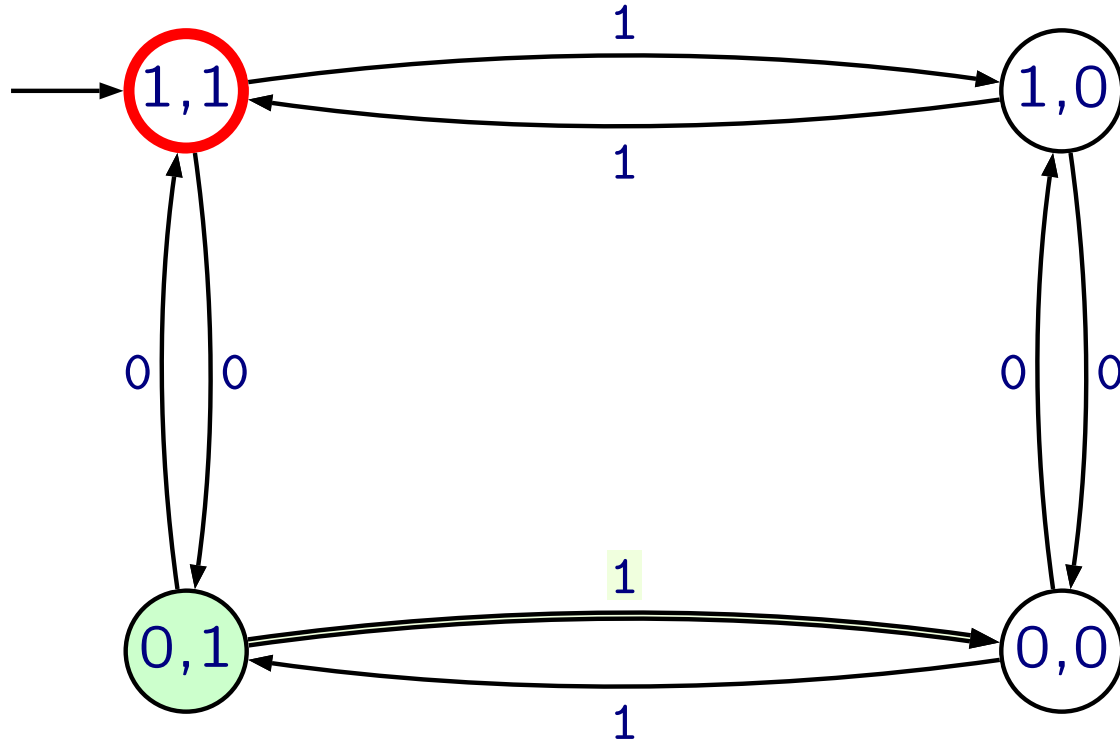

parity test



Akzeptieren

input tap

0

0

0

1

0

1

state transition graph

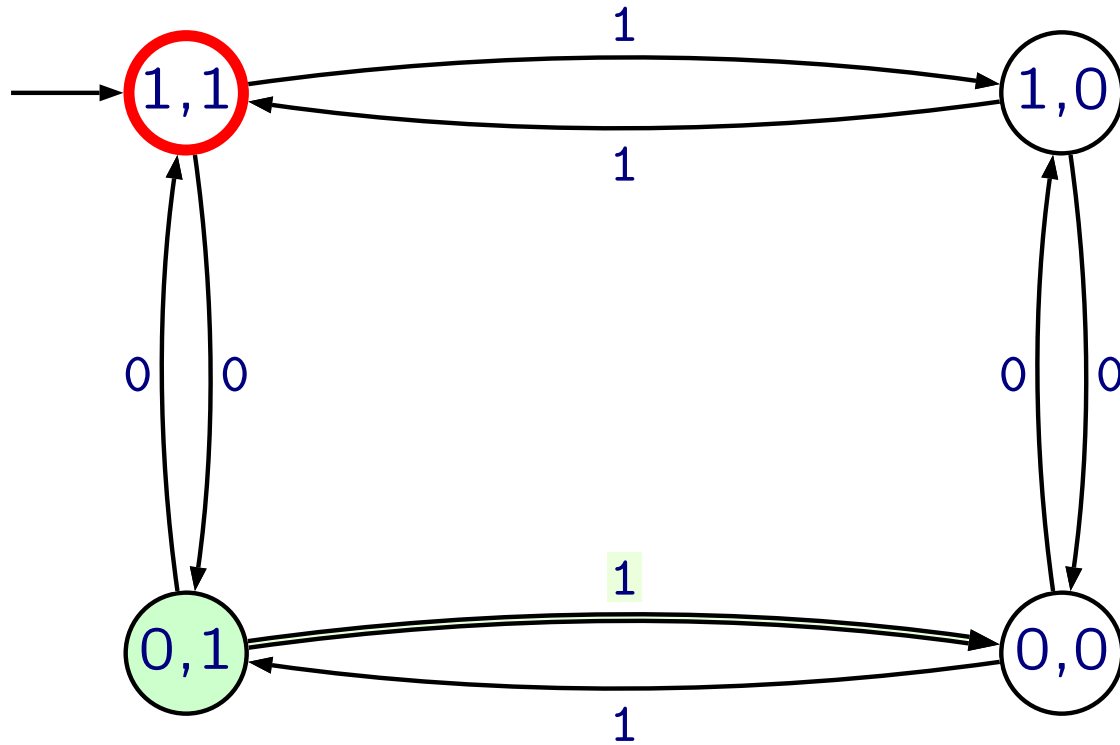

parity test



Akzeptieren

input ta

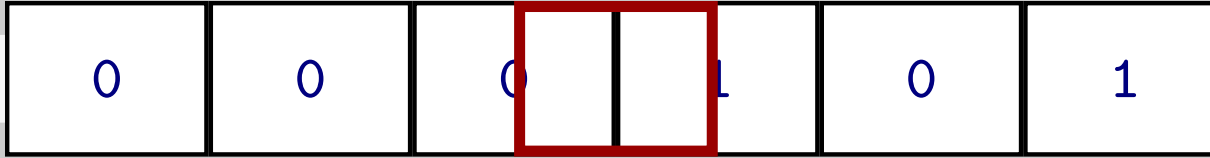

state transition graph

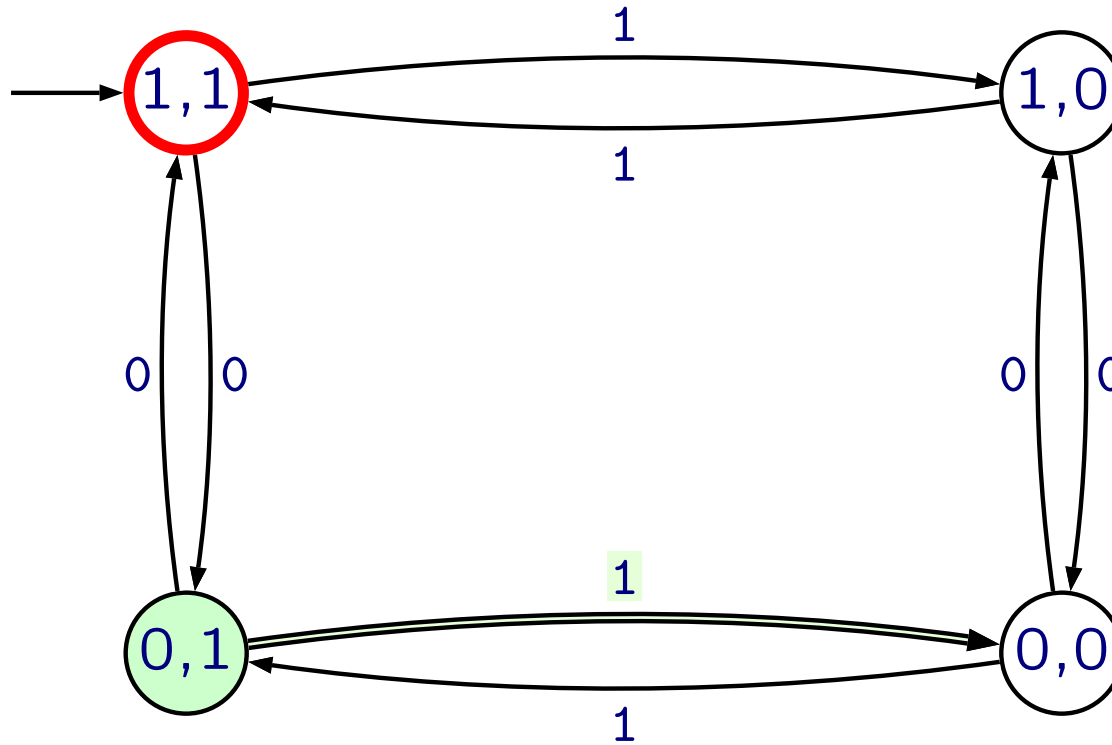

parity test



Akzeptieren

input ta

0

0

0

1

0

1

state transition graph

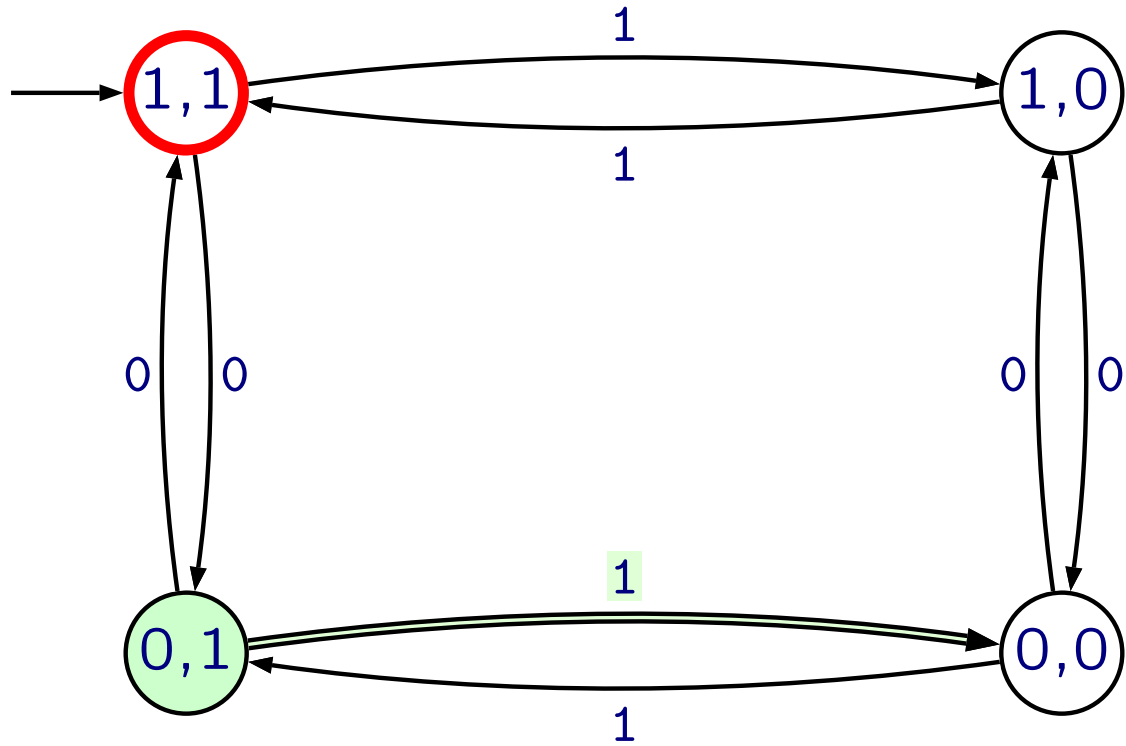

parity test



Akzeptieren

input t

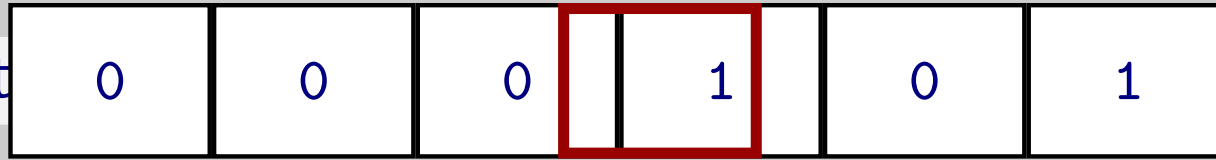

state transition graph

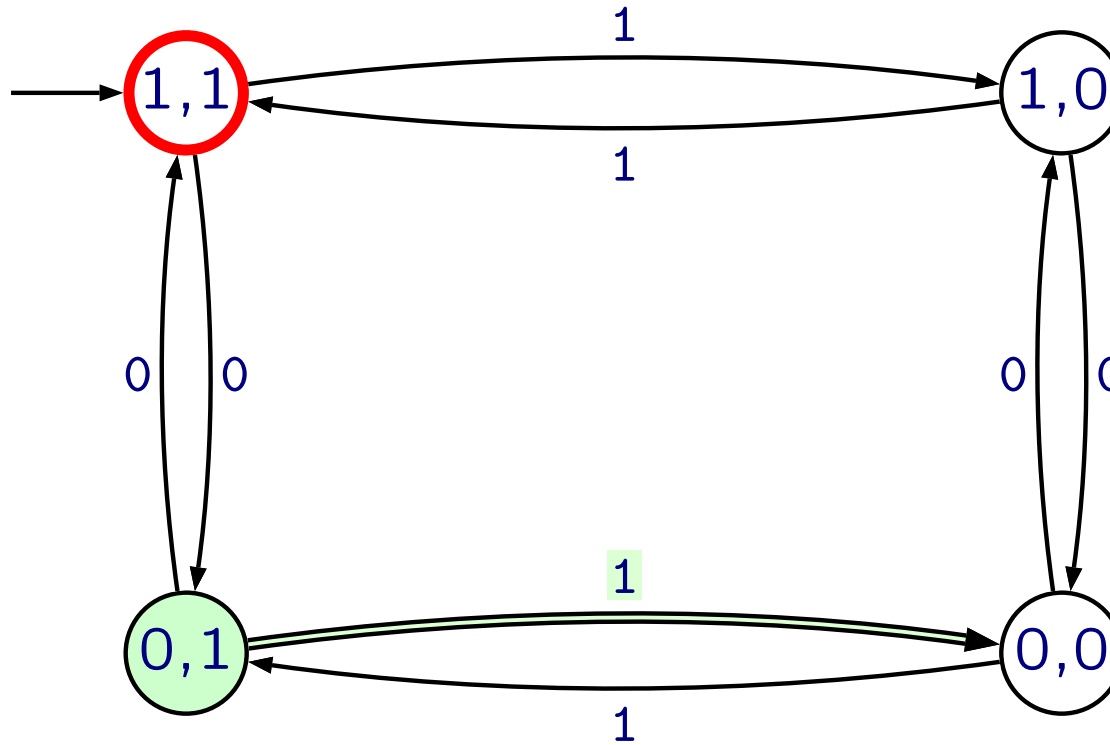

parity test



Akzeptieren

input

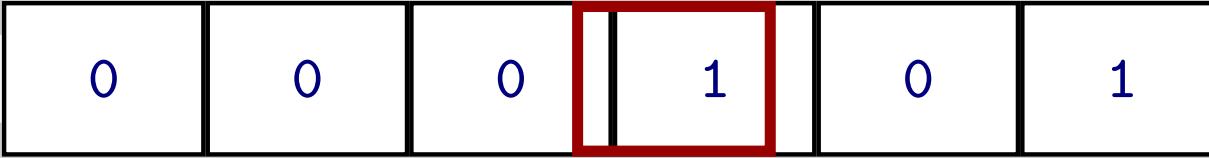

state transition graph

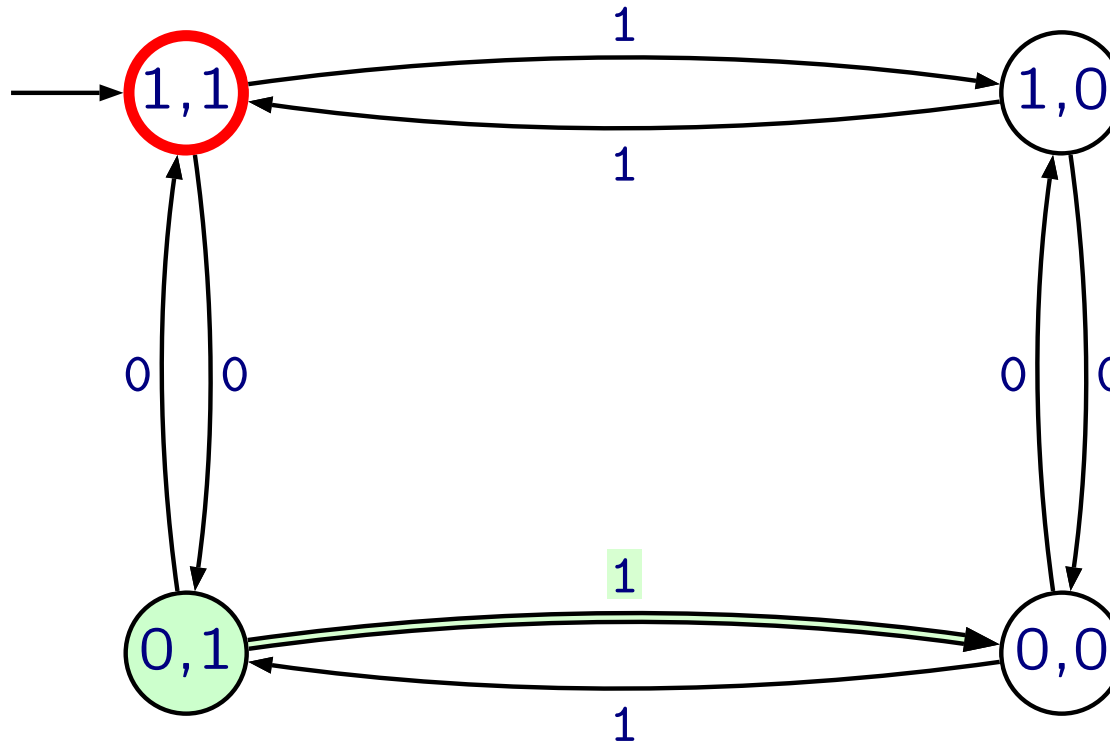

parity test



Akzeptieren

input

0

0

0

1

0

1

state transition graph

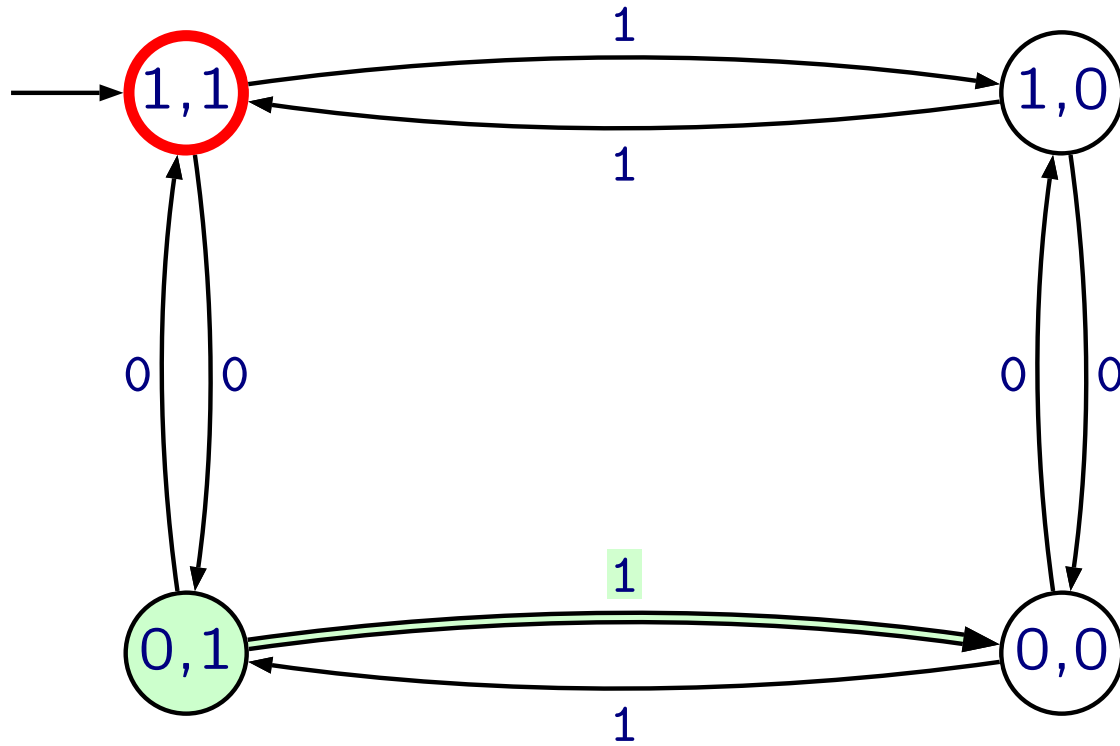

parity test



Akzeptieren

input



state transition graph

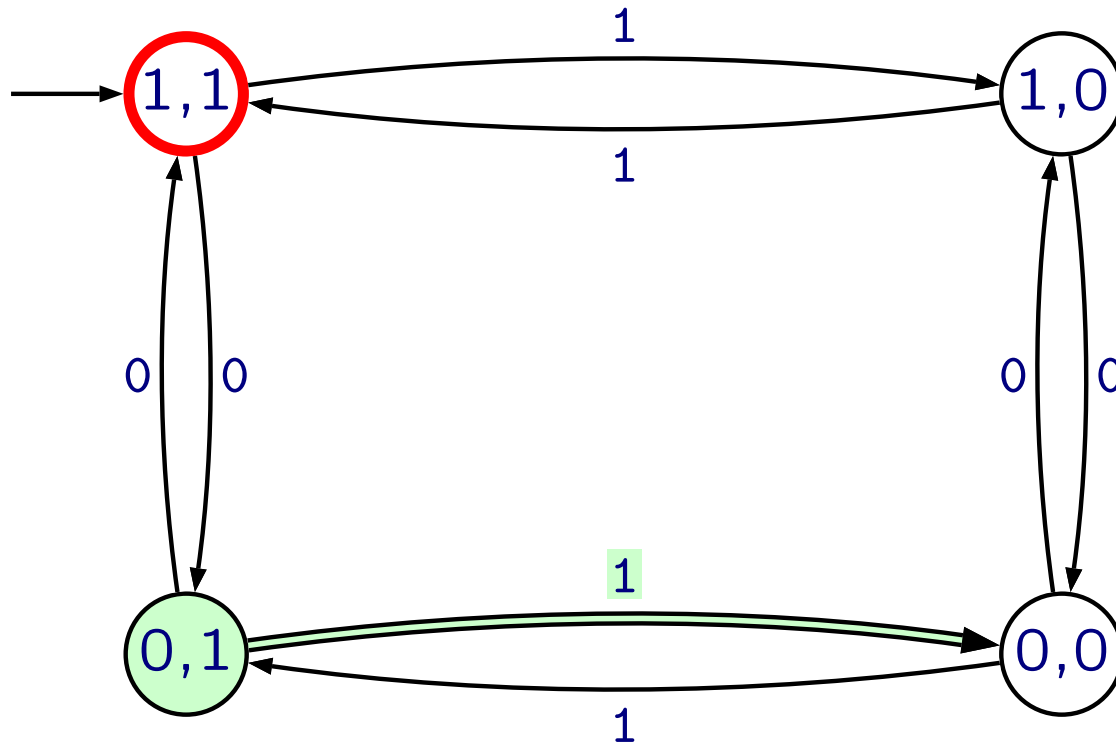

parity test



Akzeptieren

input



state transition graph

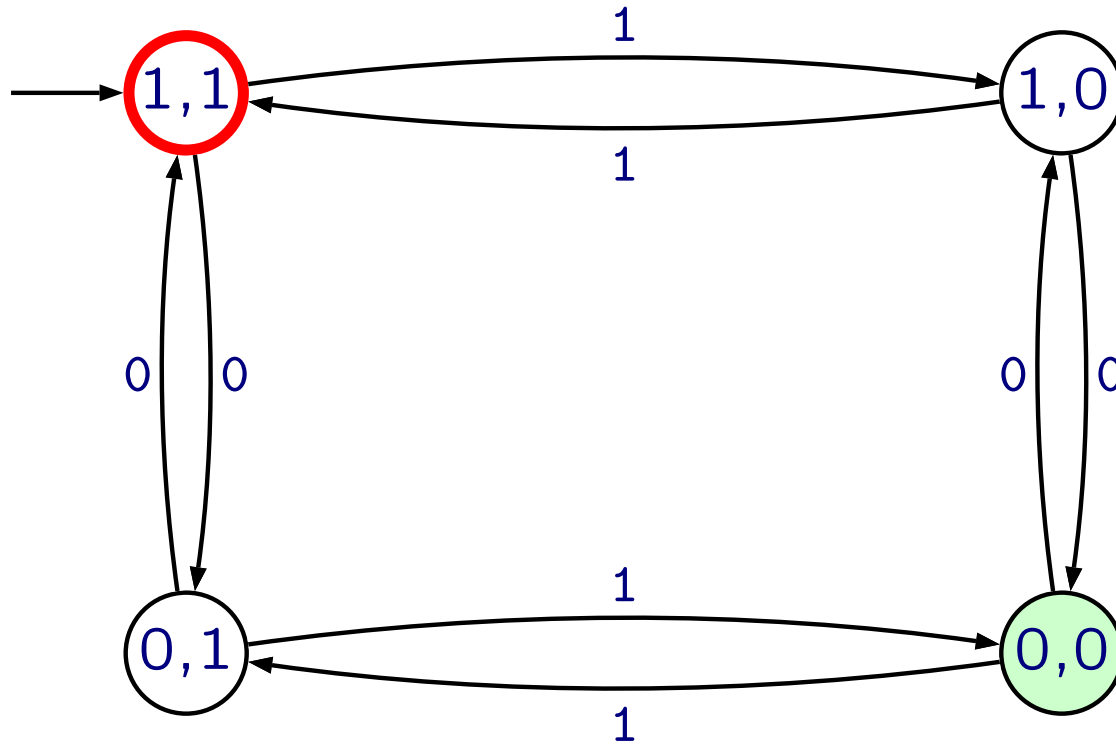

parity test



Akzeptieren

input

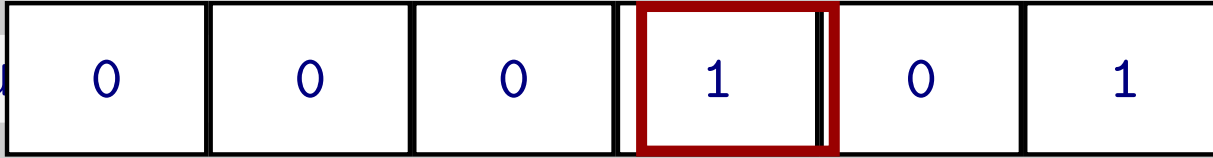

state transition graph

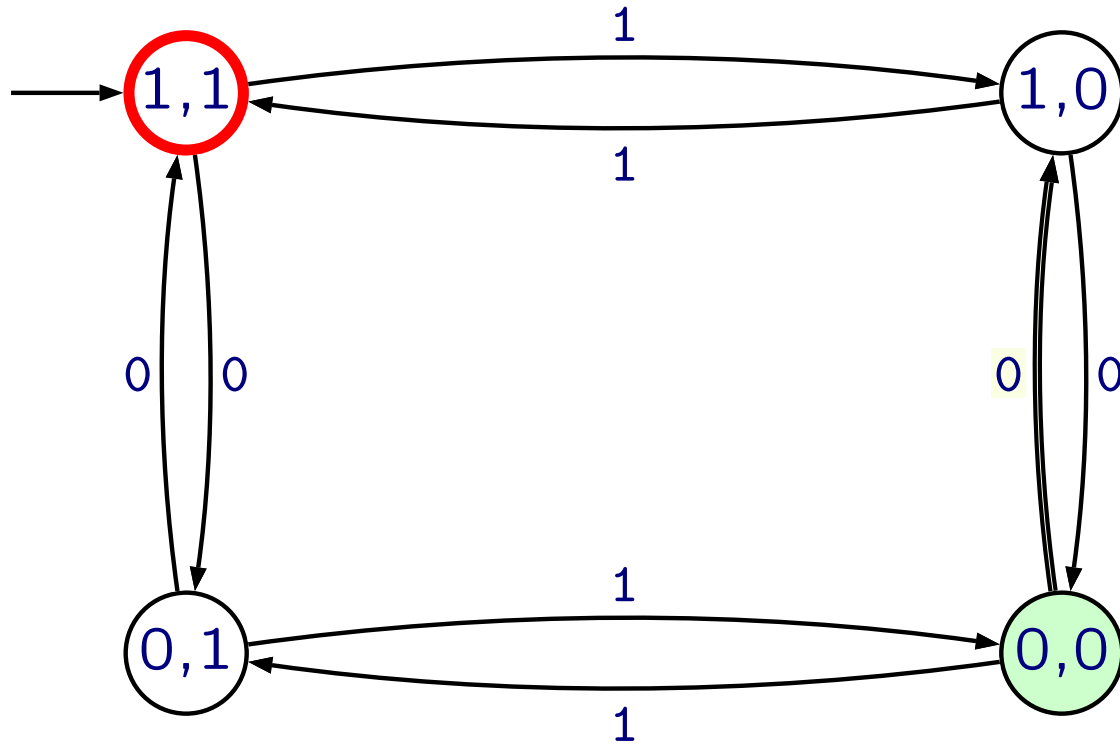

parity test



Akzeptieren

input

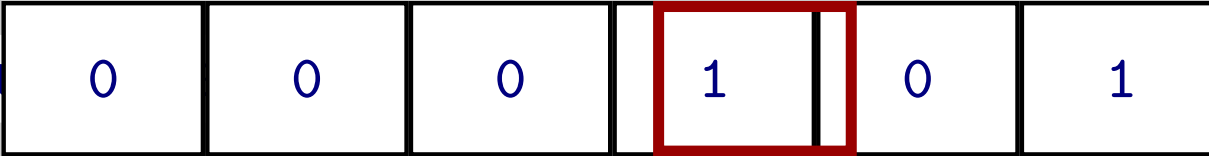

state transition graph

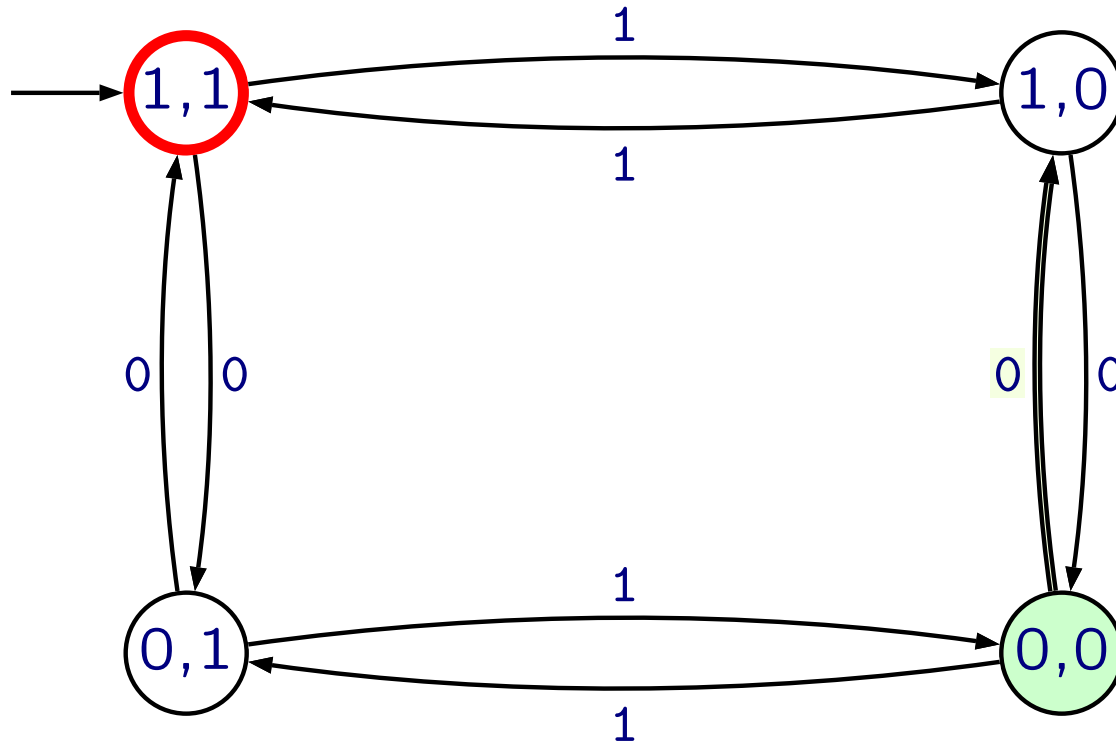

parity test



Akzeptieren

inp

0

0

0

1

0

1

state transition graph

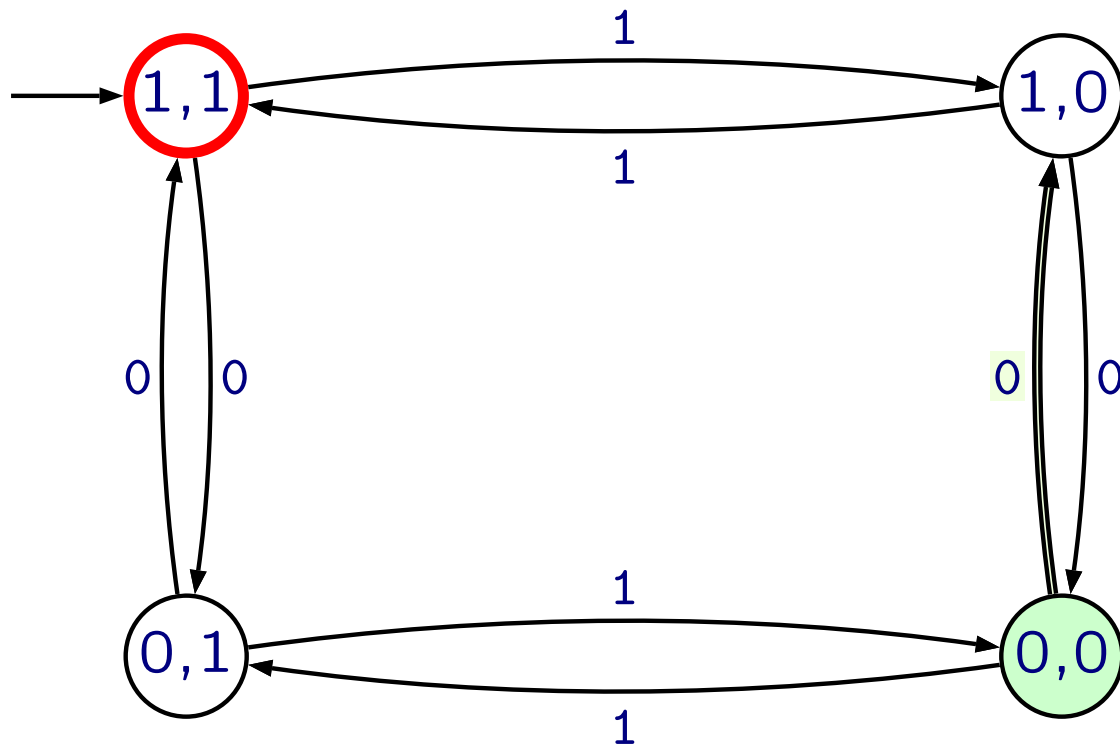

parity test



Akzeptieren

in

0

0

0

1

0

1

state transition graph

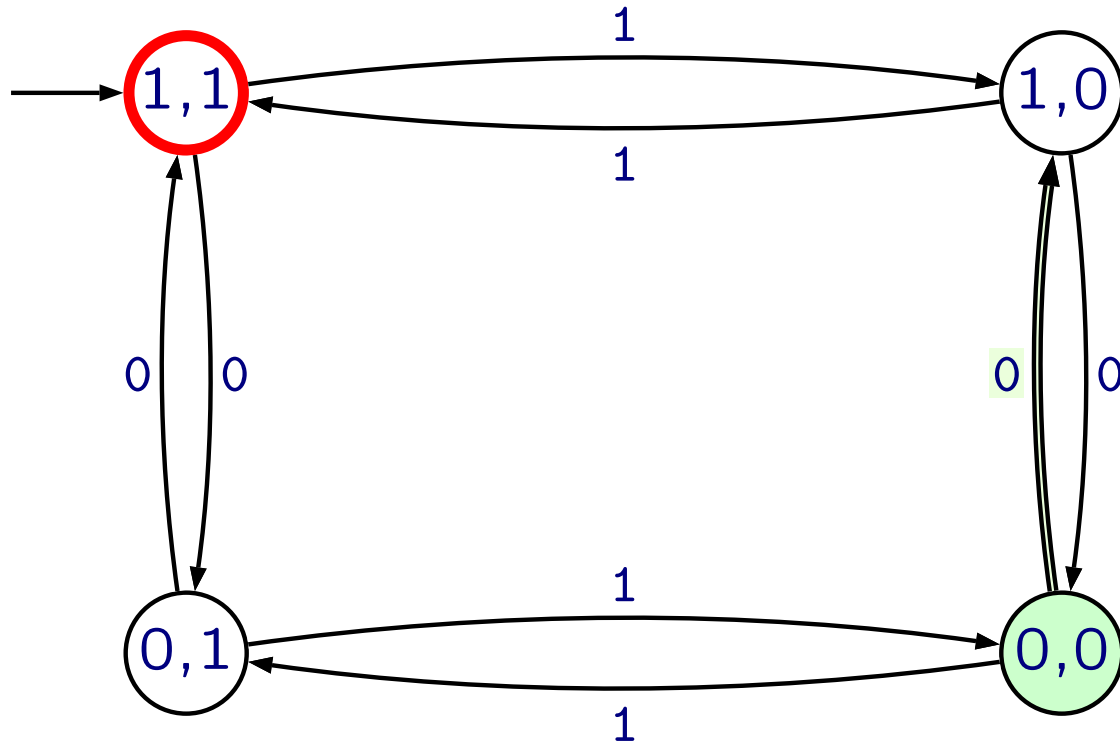

parity test



Akzeptieren

in

0

0

0

1

0

1

state transition graph

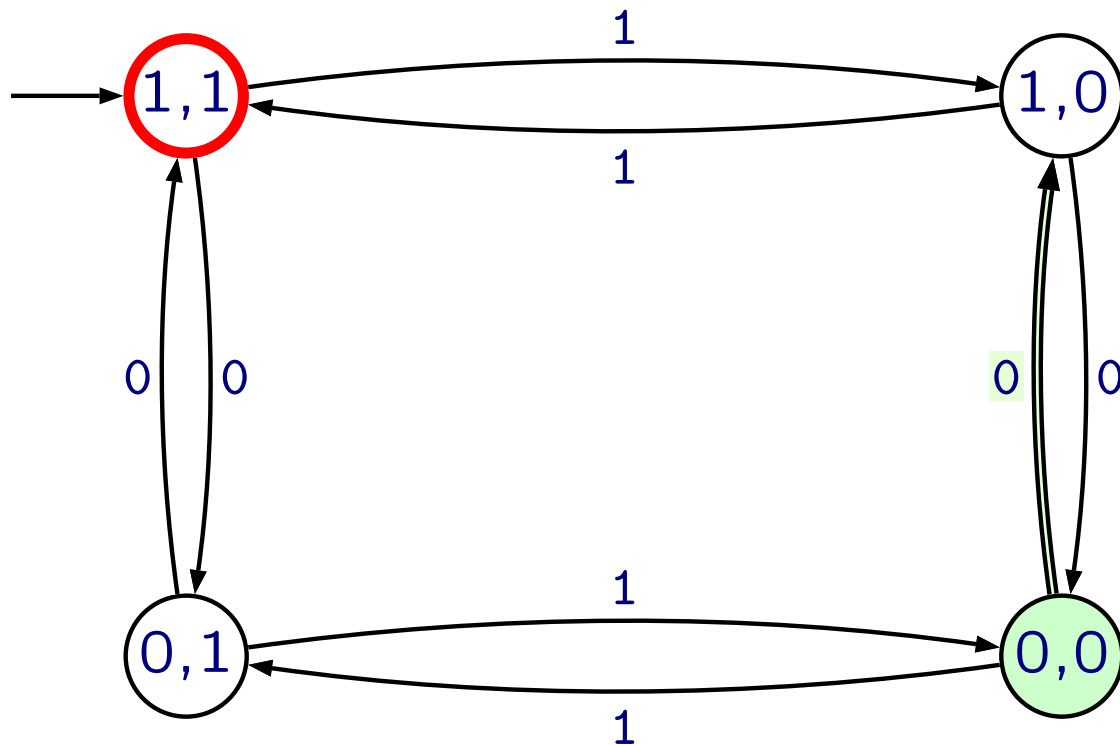

parity test



Akzeptieren

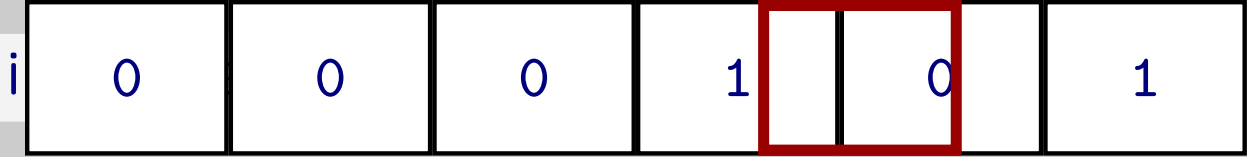

state transition graph

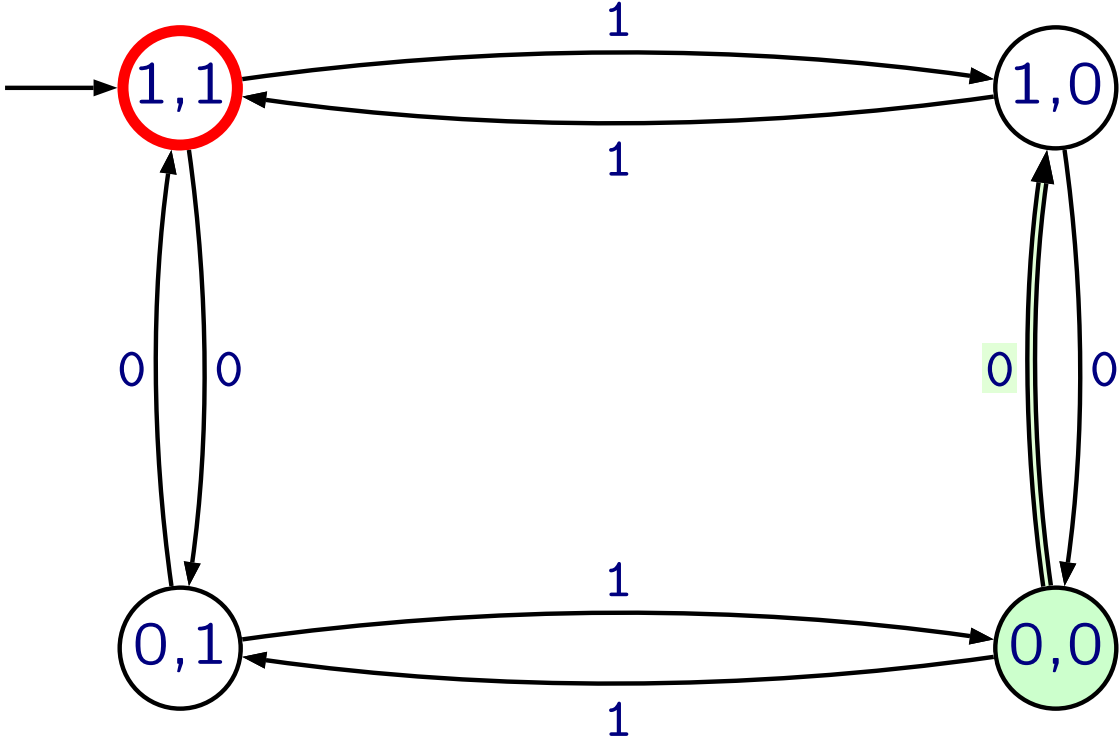

parity test



Akzeptieren

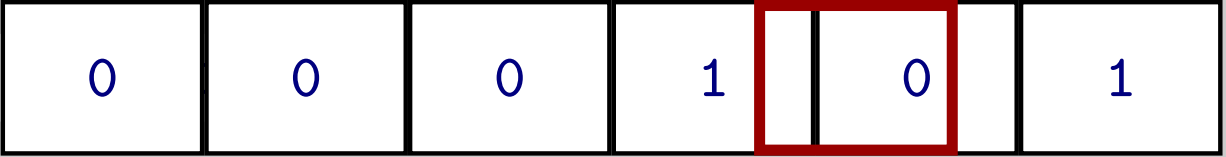

state transition graph

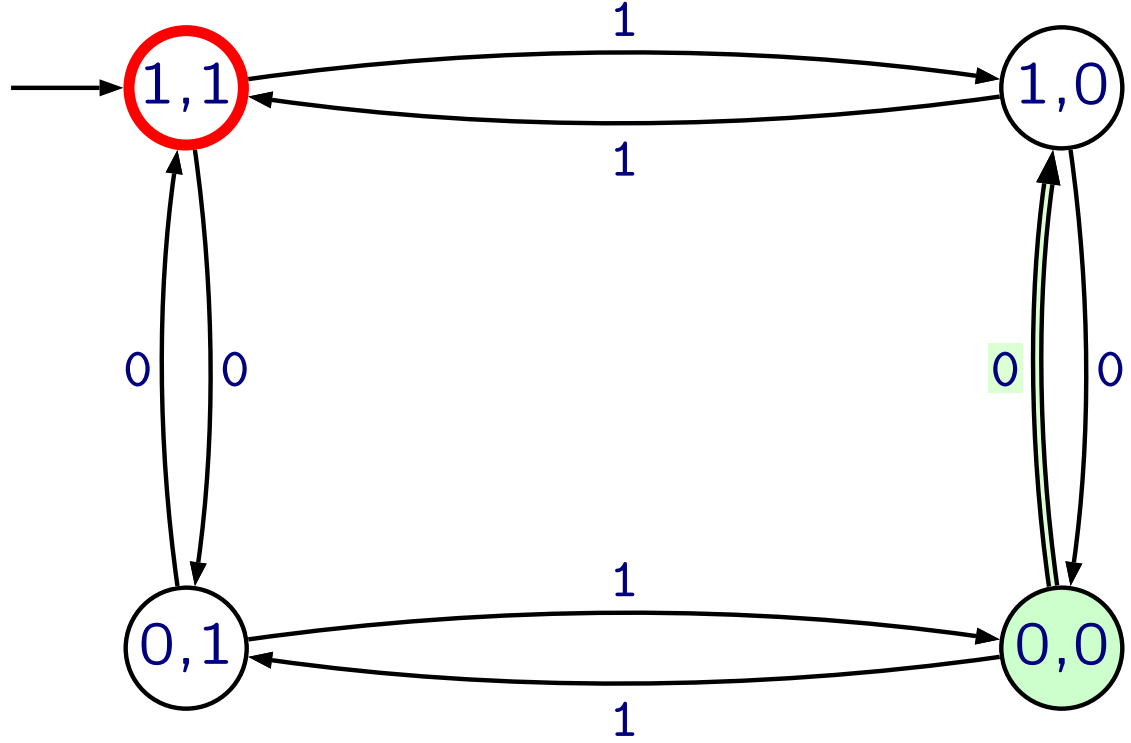

parity test

● Akzeptieren

0

0

0

1

0

1

state transition graph

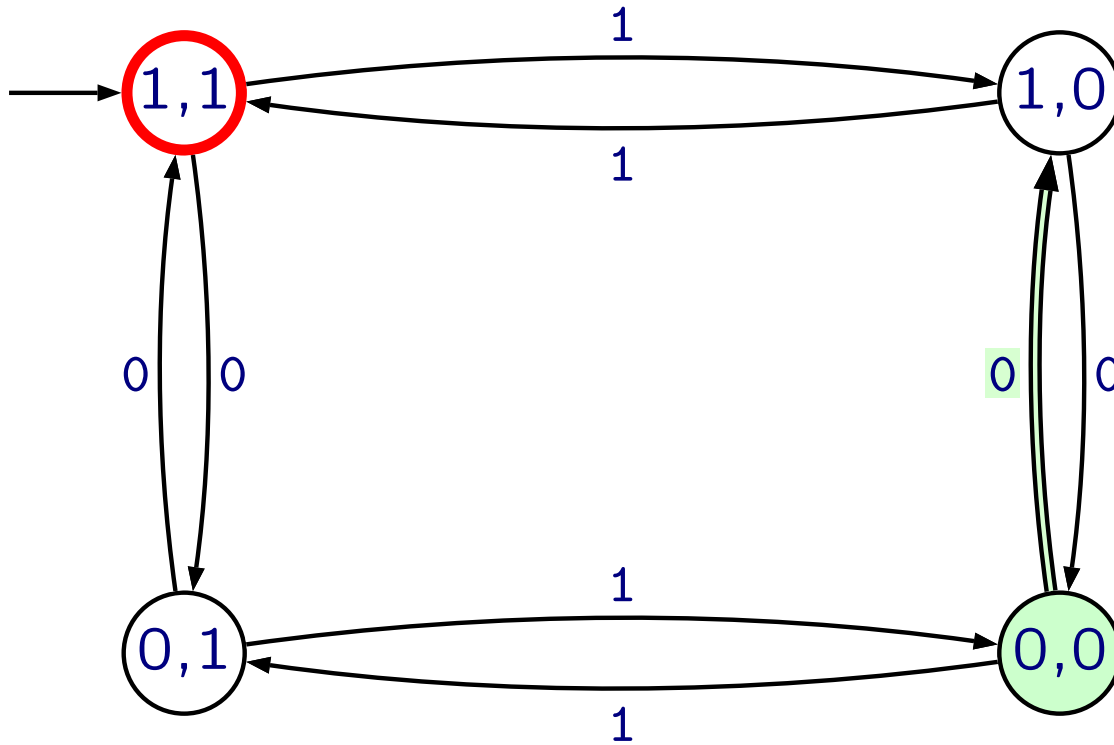

parity test



Akzeptieren

0

0

0

1

0

1

state transition graph

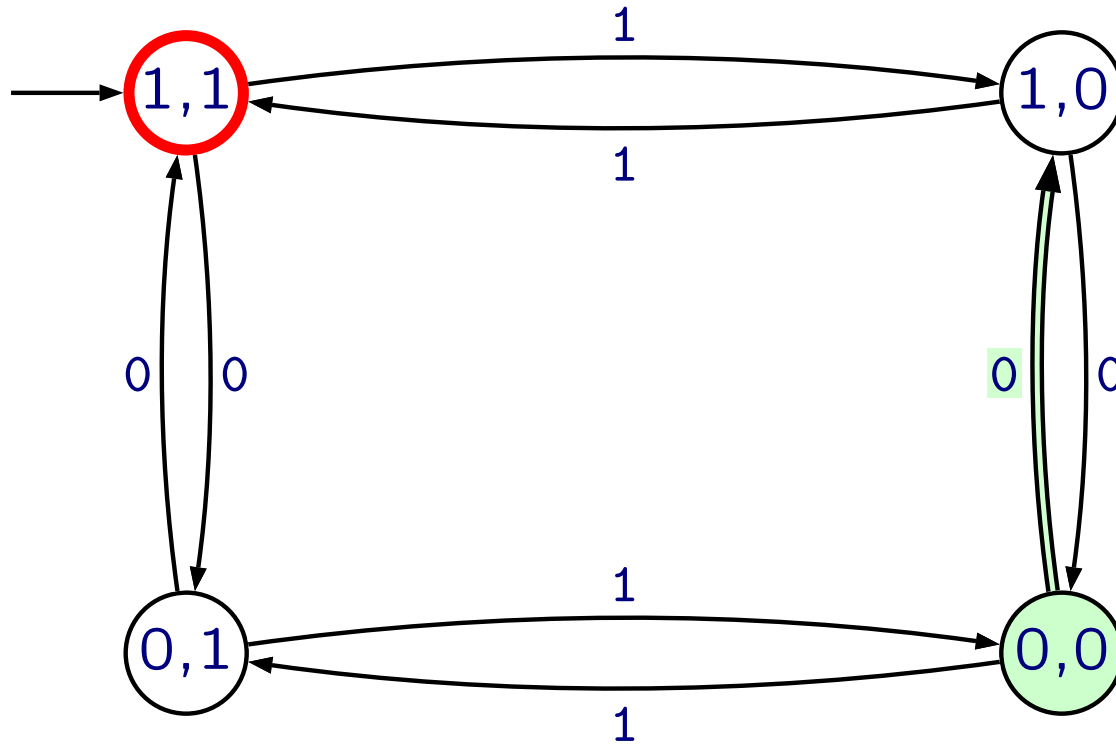

parity test



Akzeptieren

0

0

0

1

0

1

state transition graph

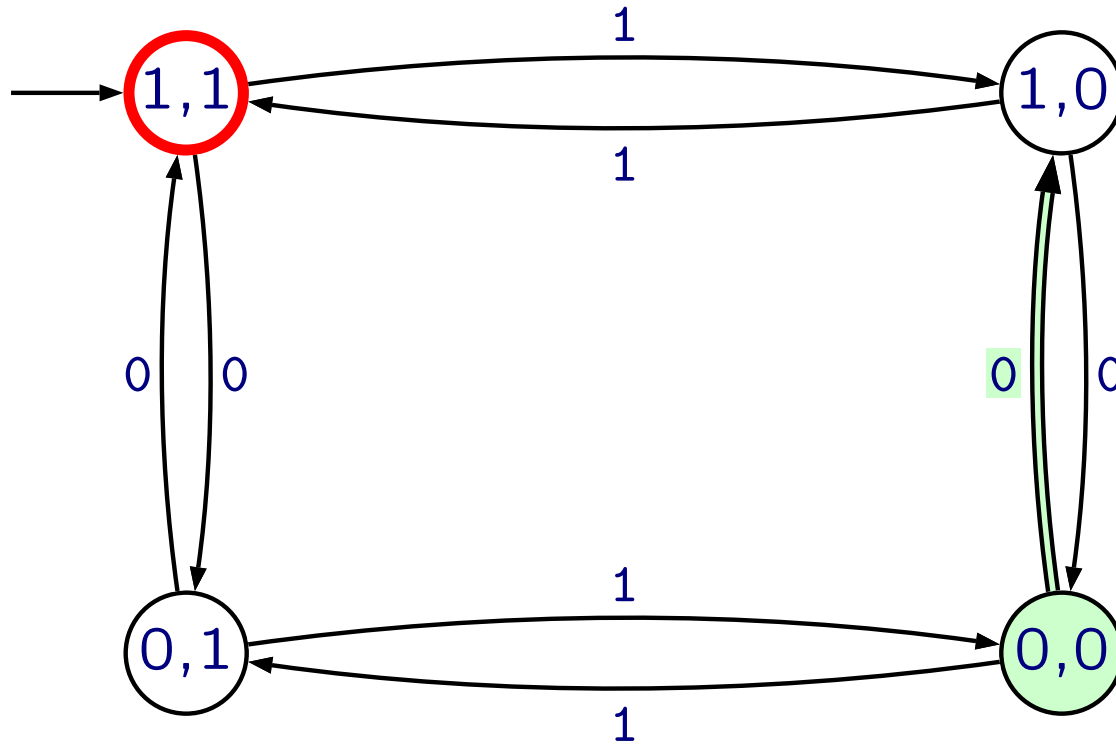

parity test



Akzeptieren

0

0

0

1

0

1

state transition graph

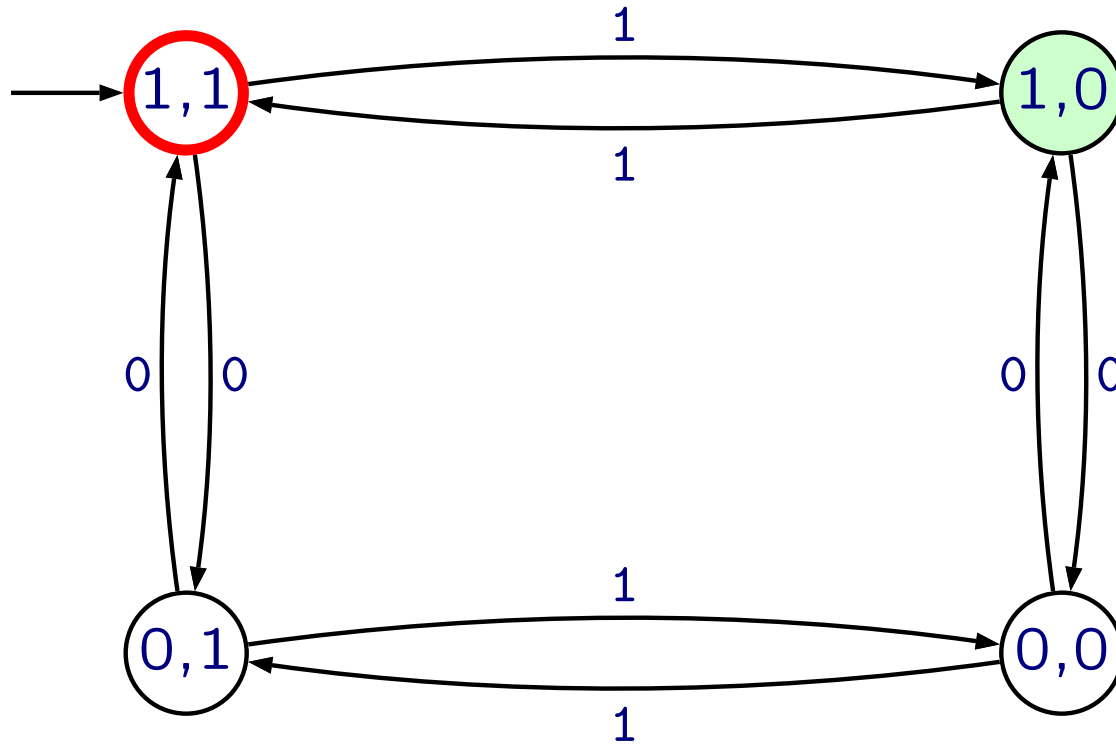

parity test



Akzeptieren

0	0	0	1	0	1
---	---	---	---	---	---

state transition graph

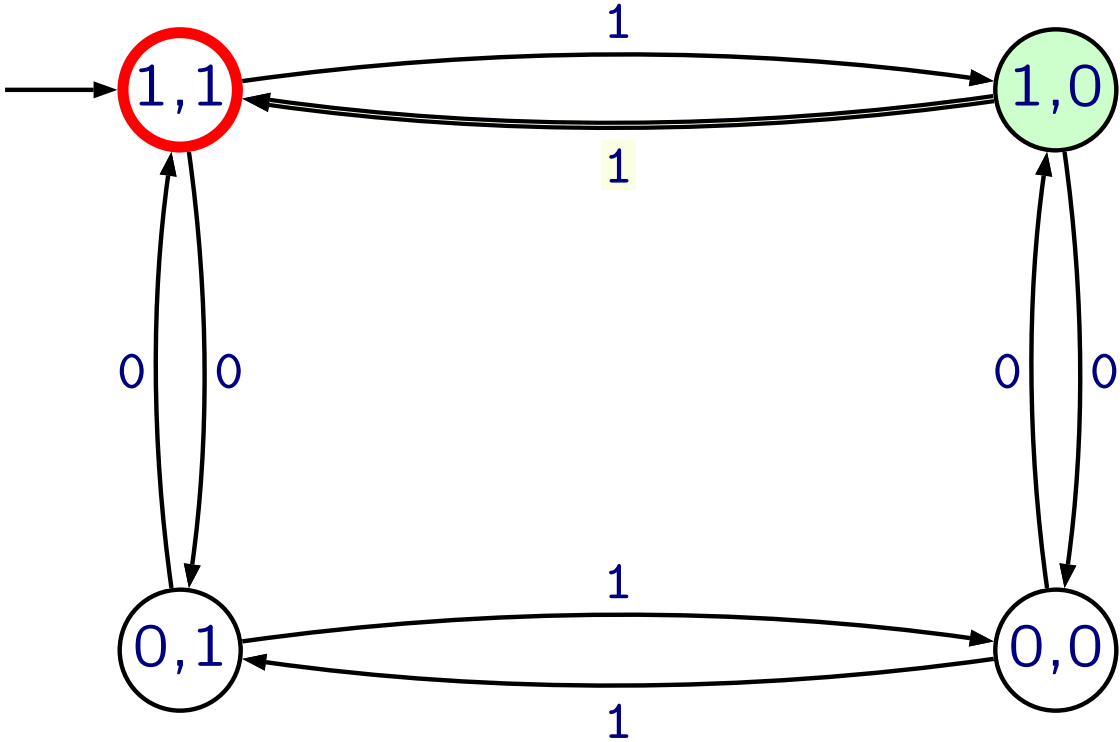

parity test



Akzeptieren

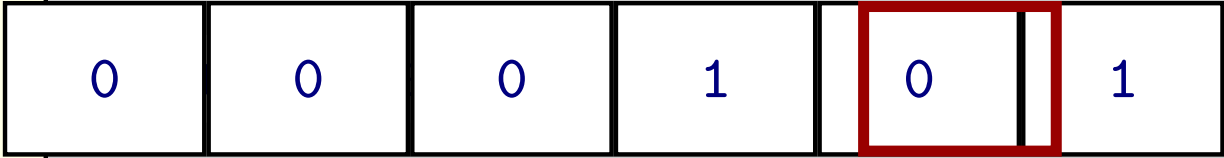

state transition graph

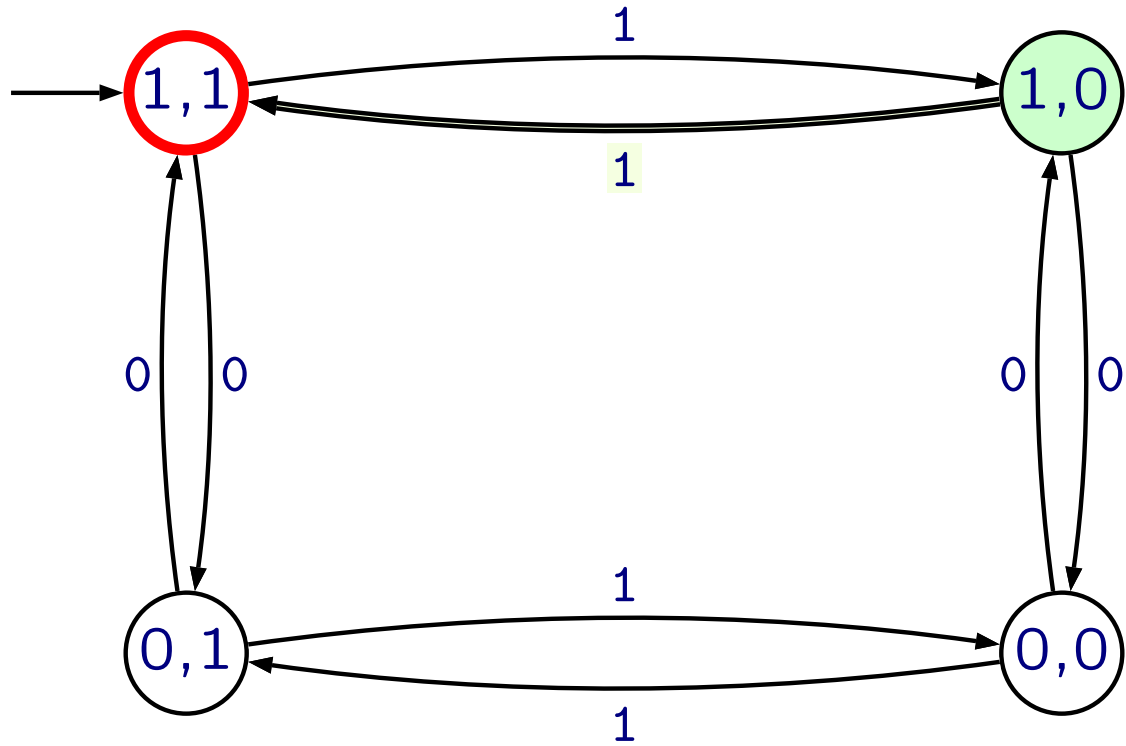

parity test



Akzeptieren

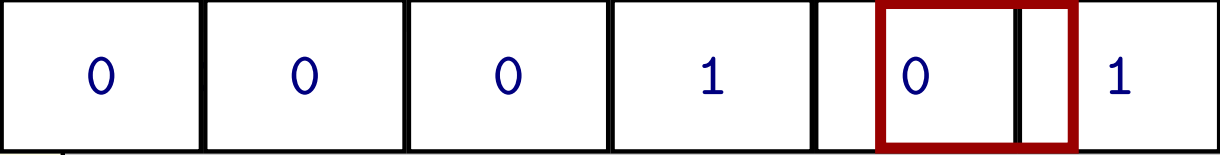

state transition graph

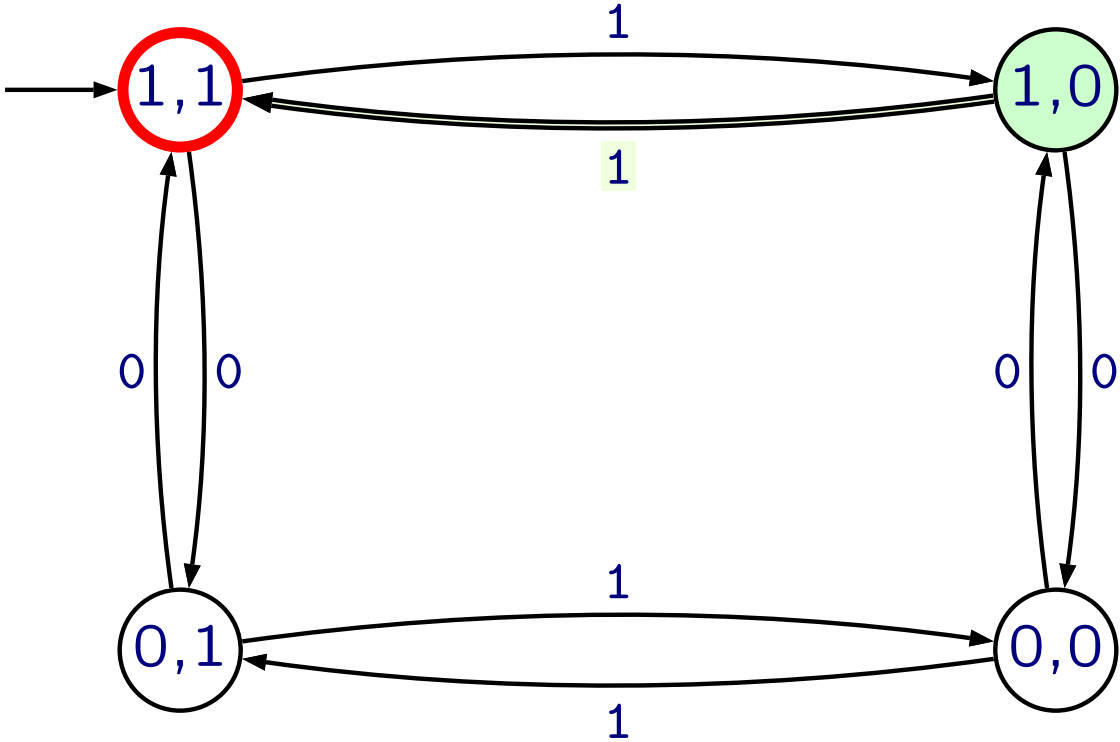

parity test



Akzeptieren

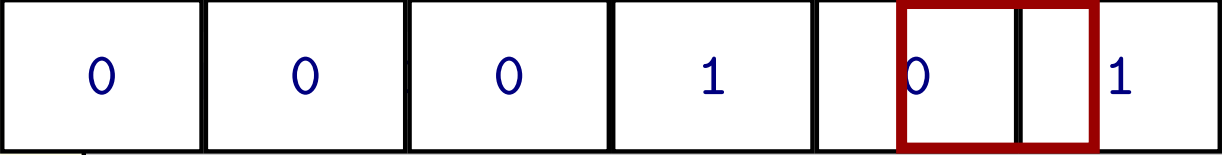

state transition graph

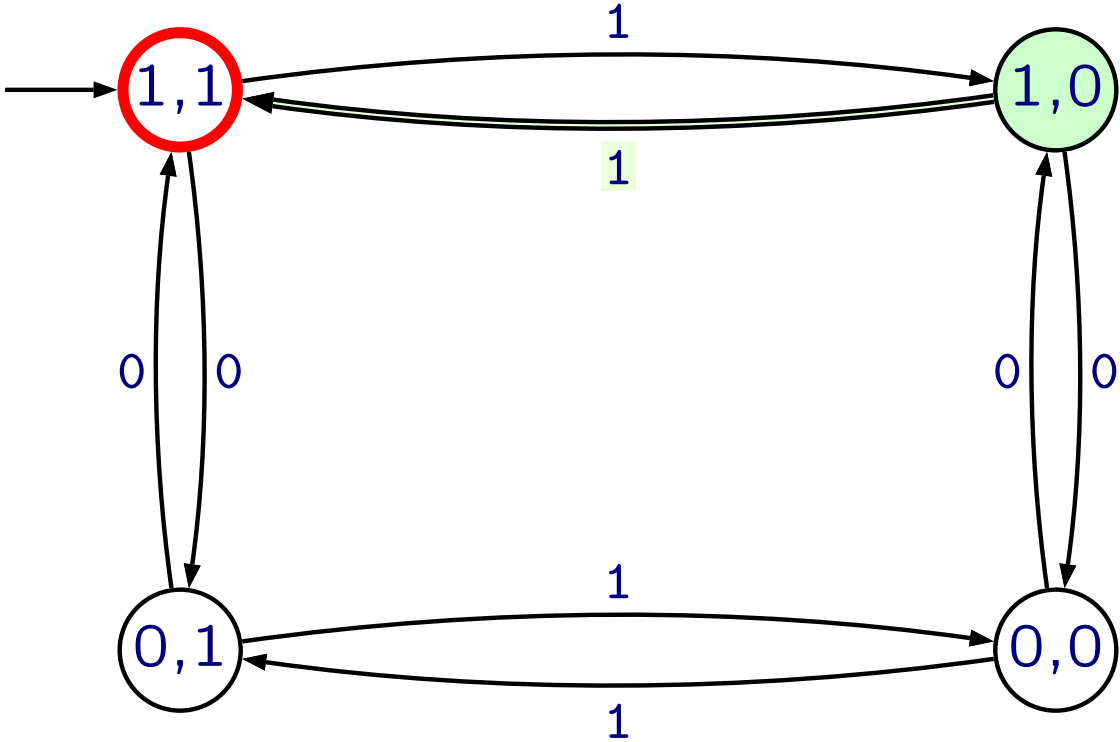

parity test



Akzeptieren



state transition graph

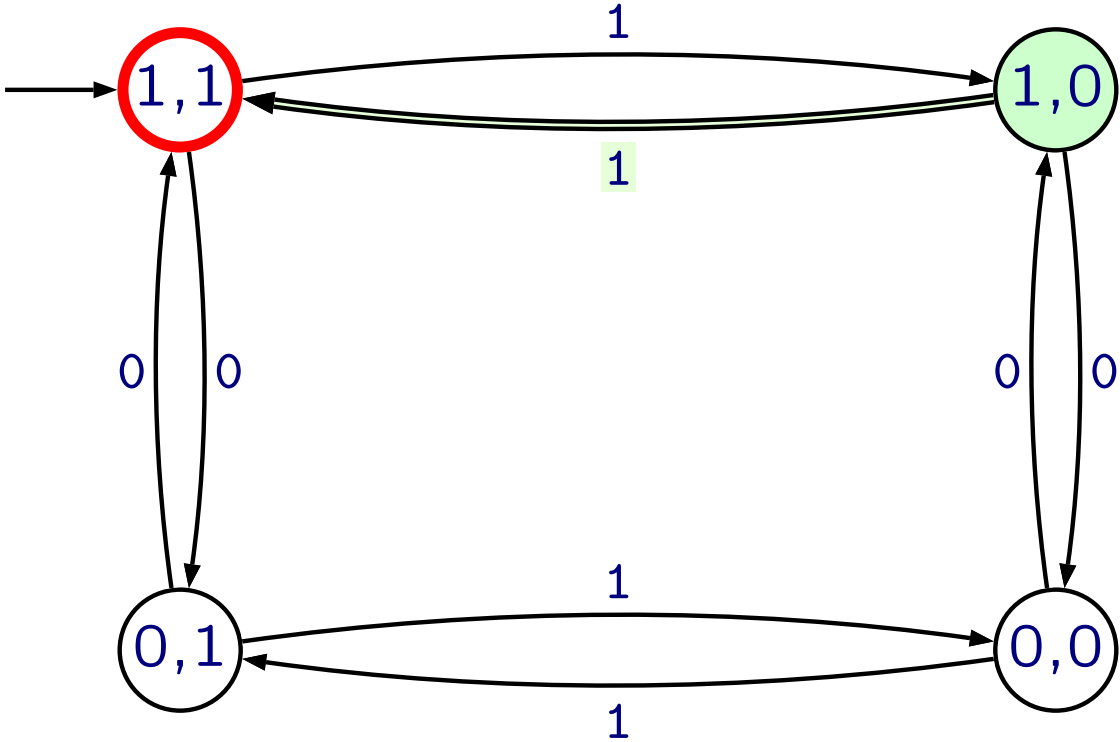

parity test



Akzeptieren

0

0

0

1

0

1

state transition graph

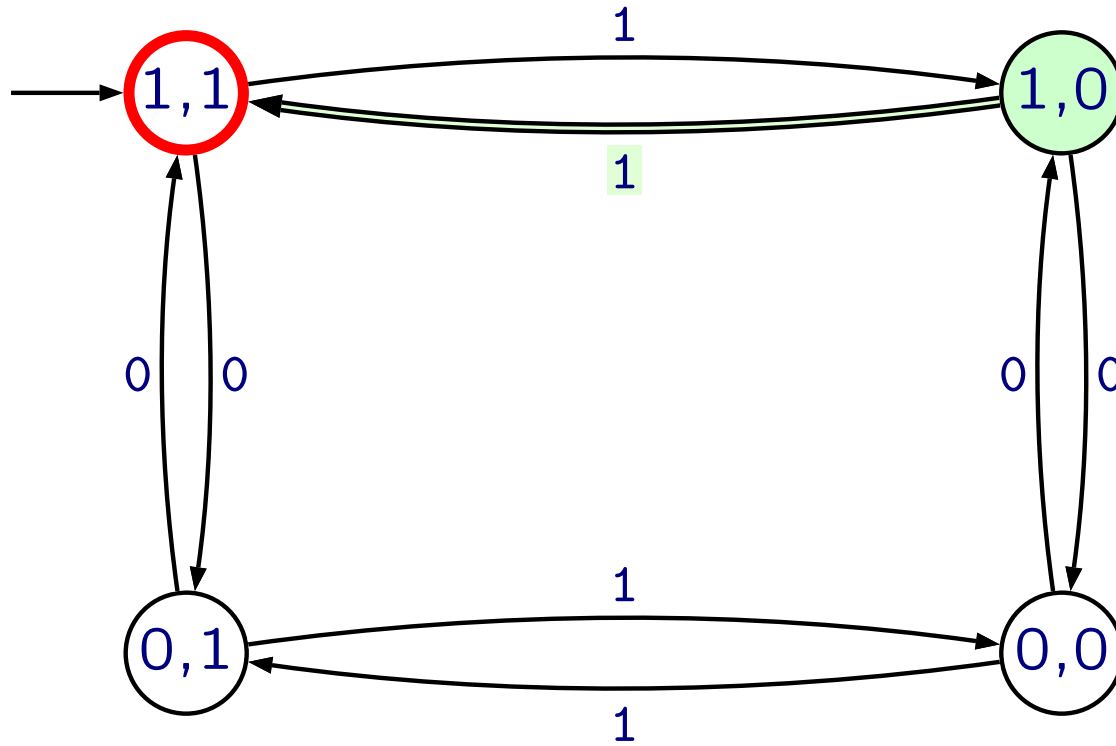

parity test



Akzeptieren

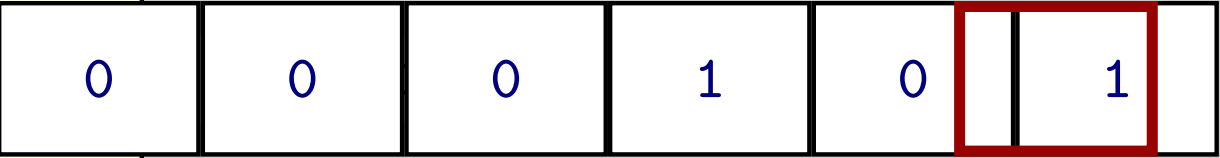

state transition graph

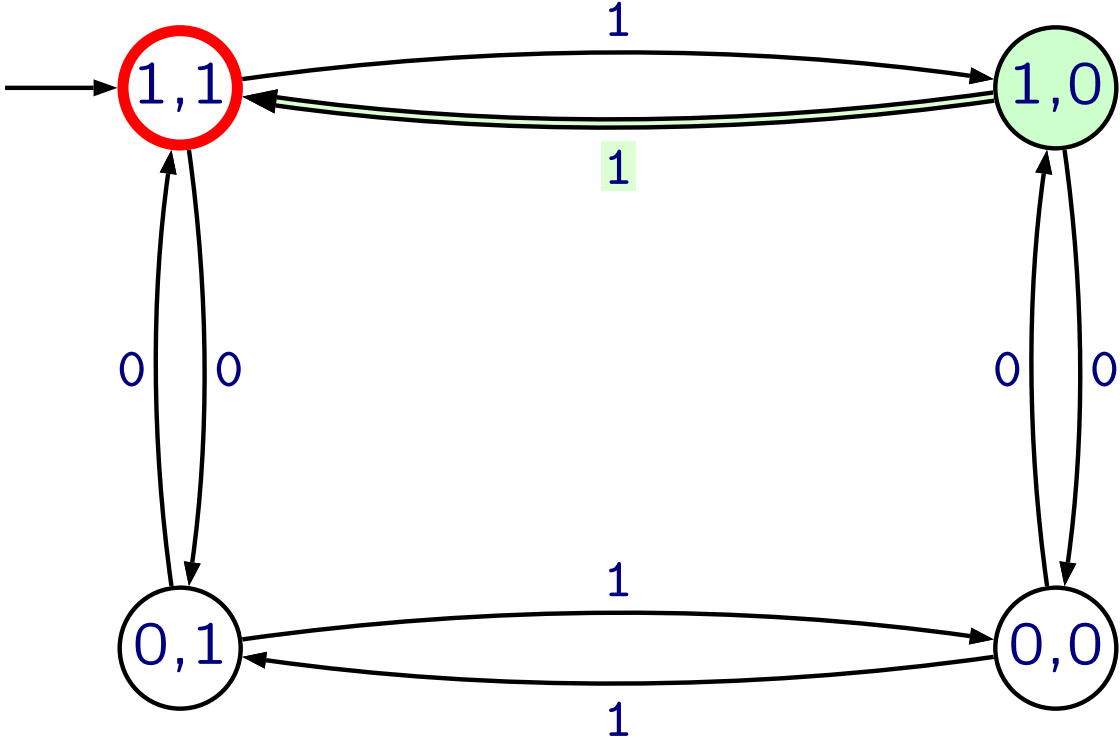

parity test

 Akzeptieren

0

0

0

1

0

1

state transition graph

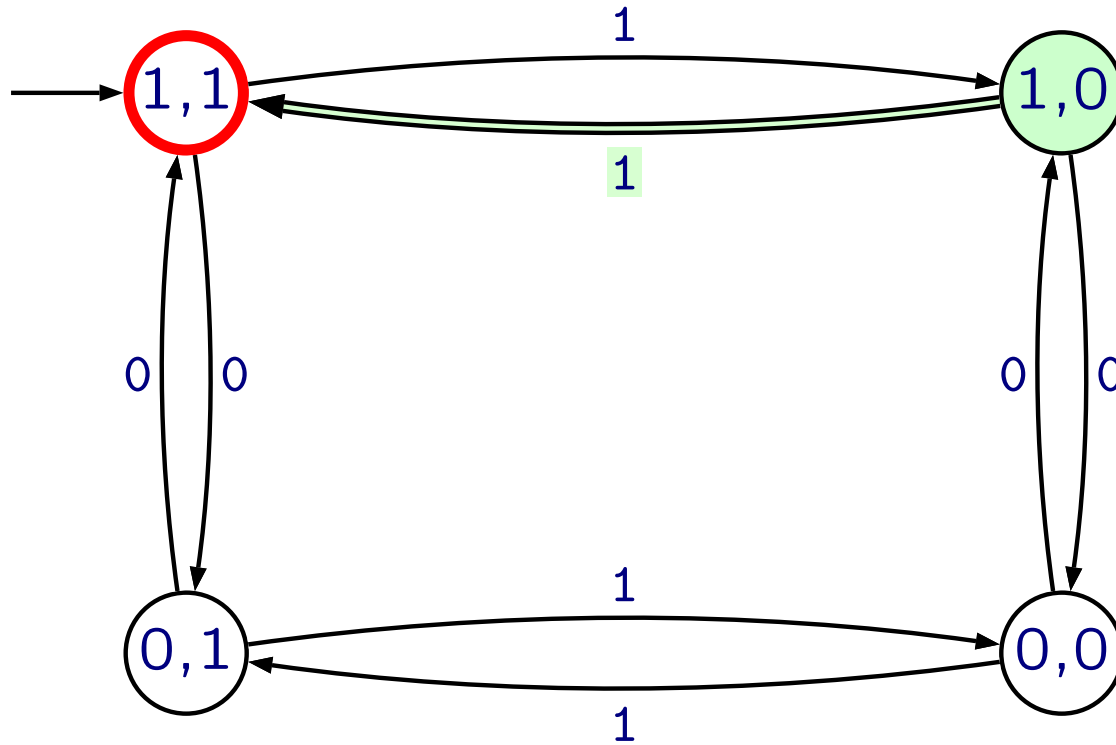

parity test



Akzeptieren

0

0

0

1

0

1

state transition graph

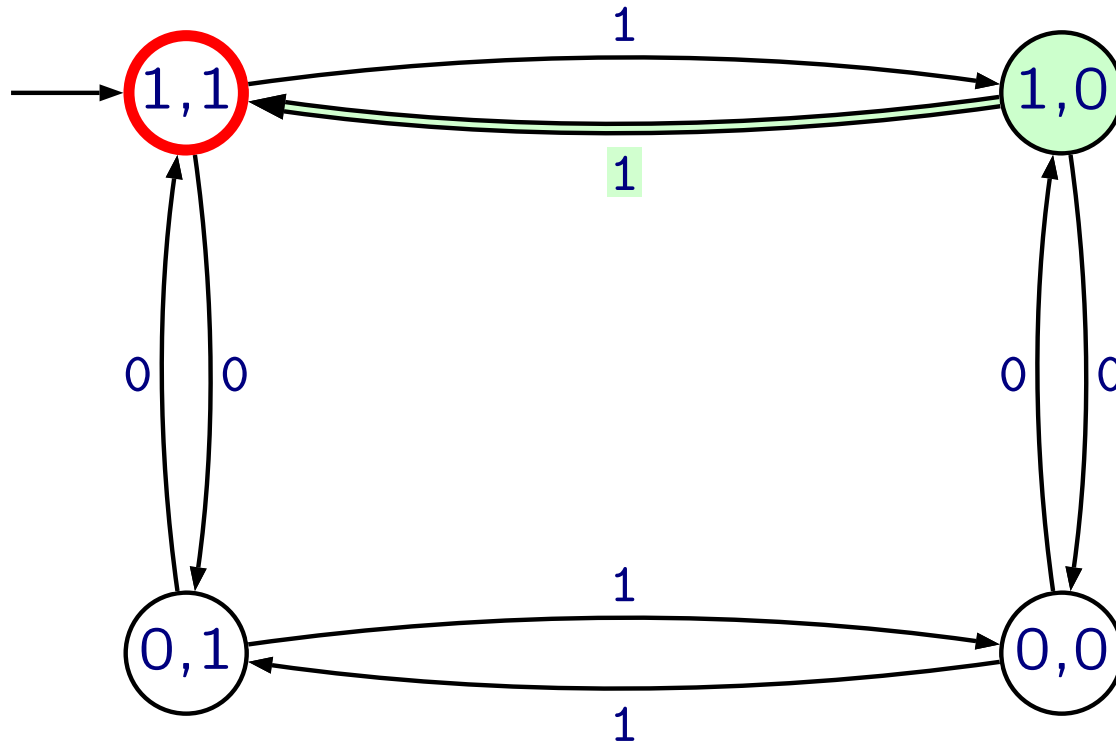

parity test



Akzeptieren

0

0

0

1

0

1

state transition graph

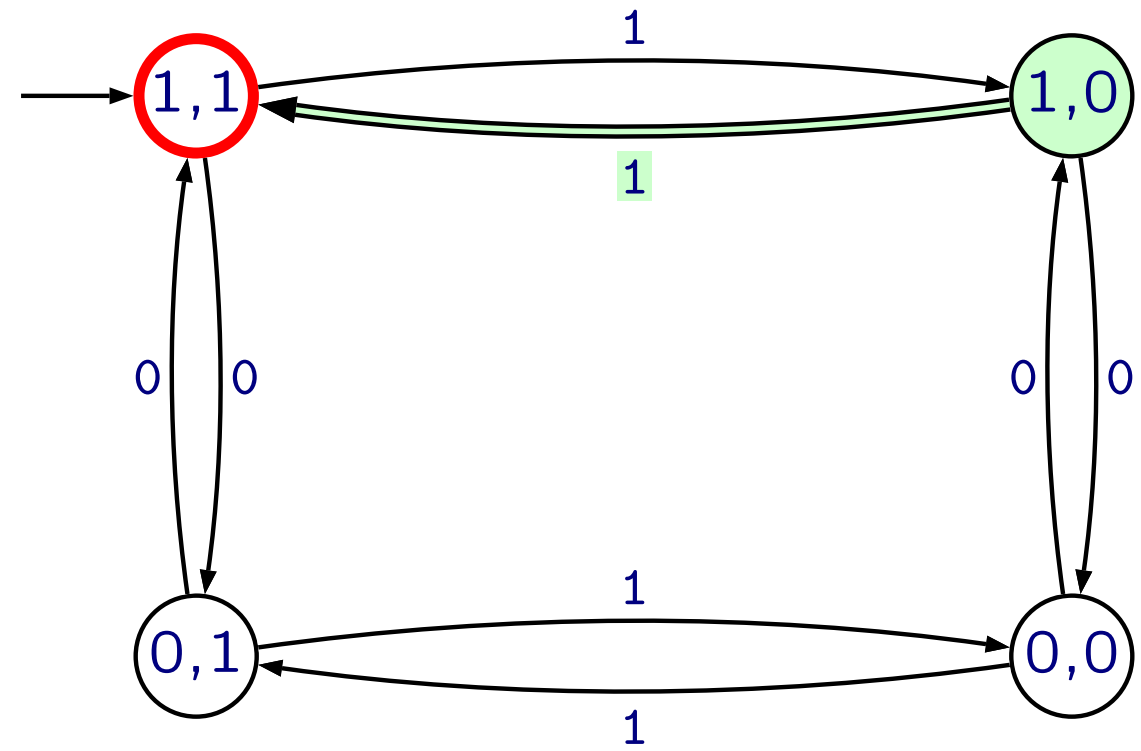

parity test



Akzeptieren

0

0

0

1

0

1

state transition graph

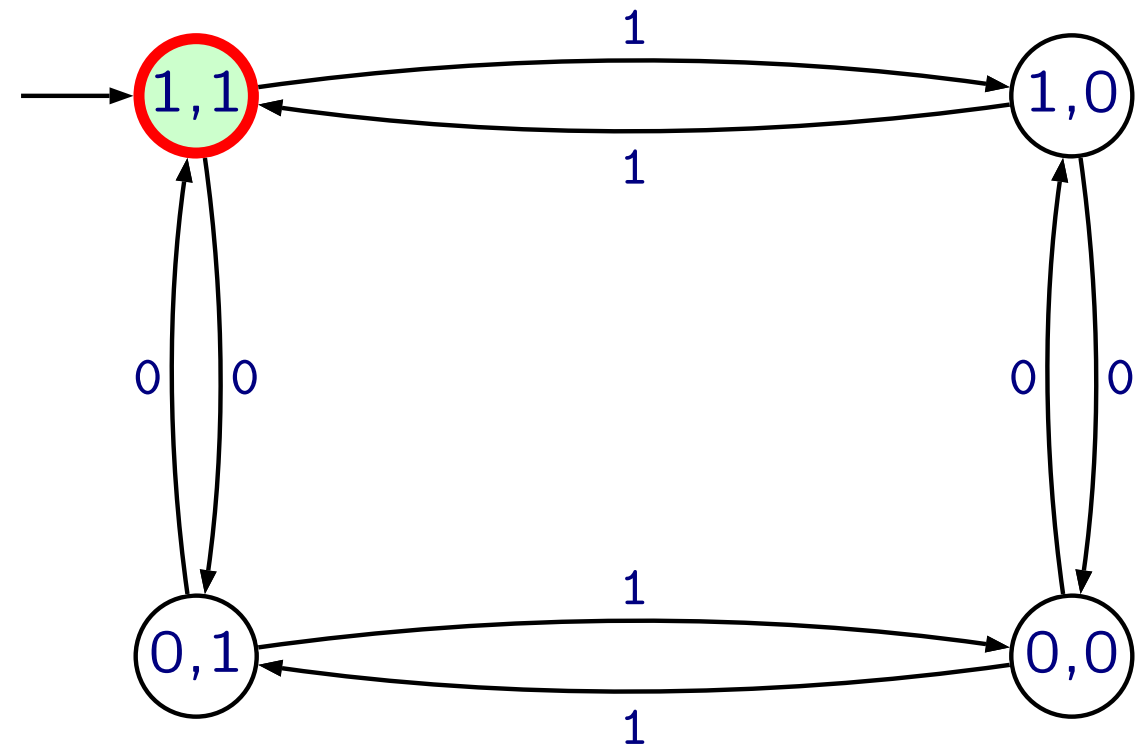

parity test



Akzeptieren

0 0 0 1 0 1

parity test

state transition graph

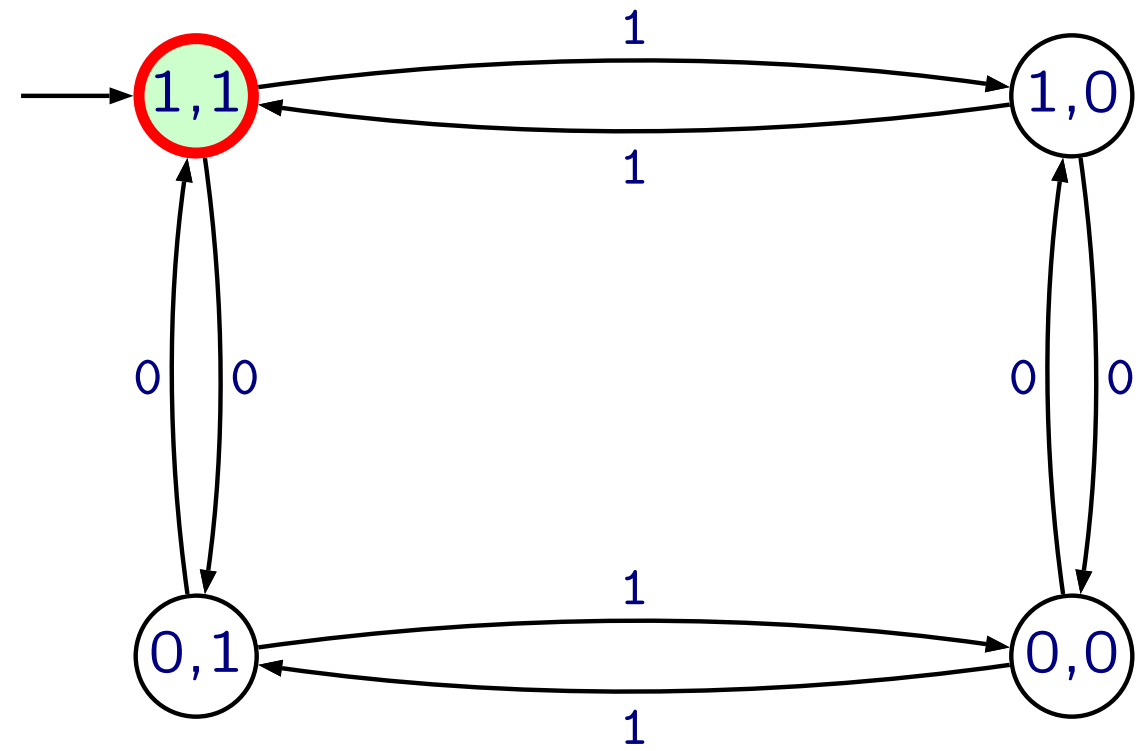

 Akzeptieren

0 0 0 1 0 1

parity test

state transition graph

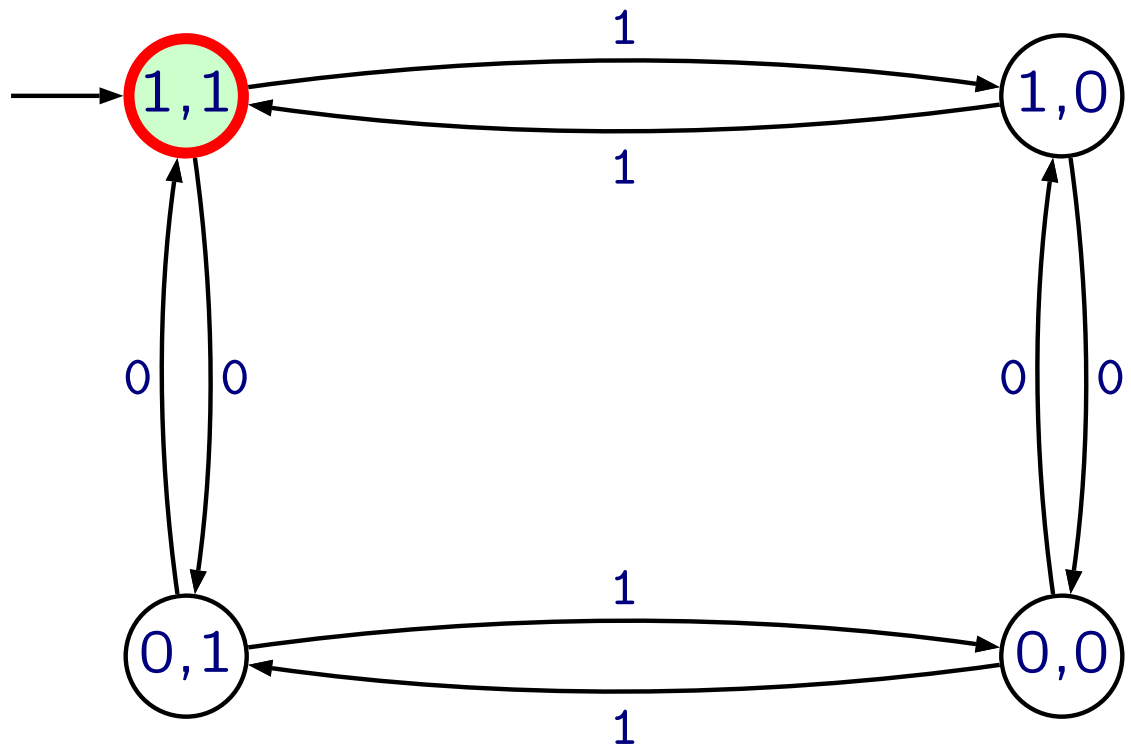

 Akzeptieren

0

0

1

0

1

state transition graph

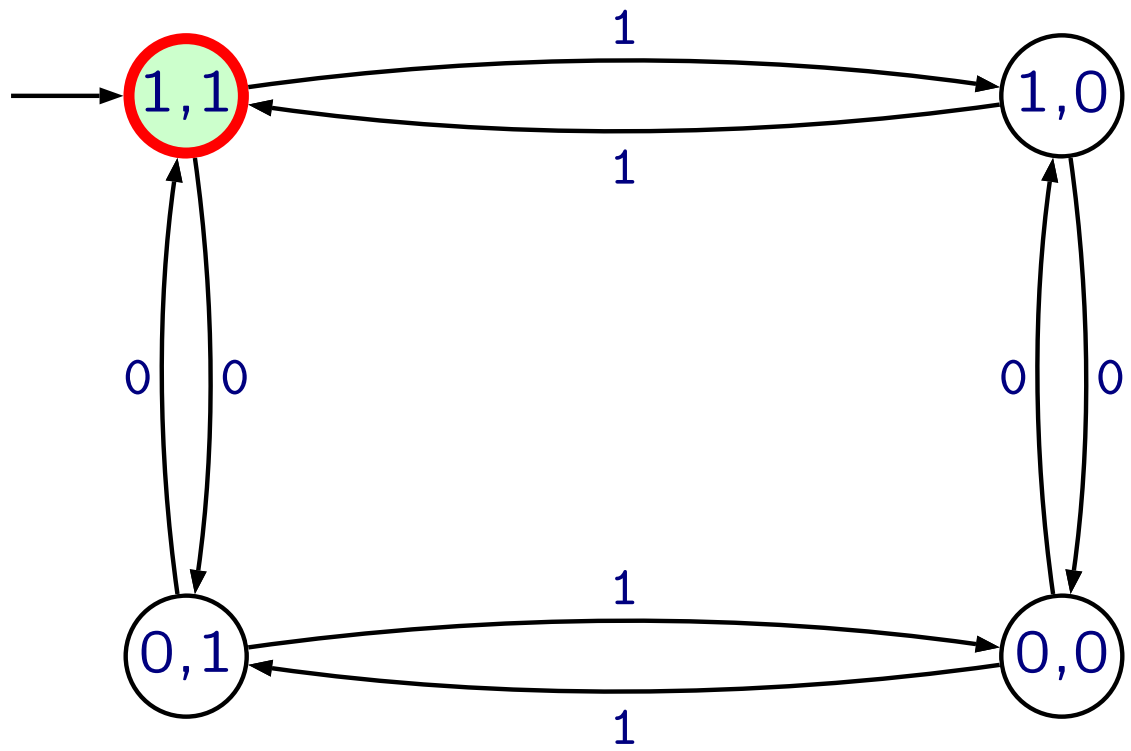

parity test



Akzeptieren

0

0

1

0

1

state transition graph

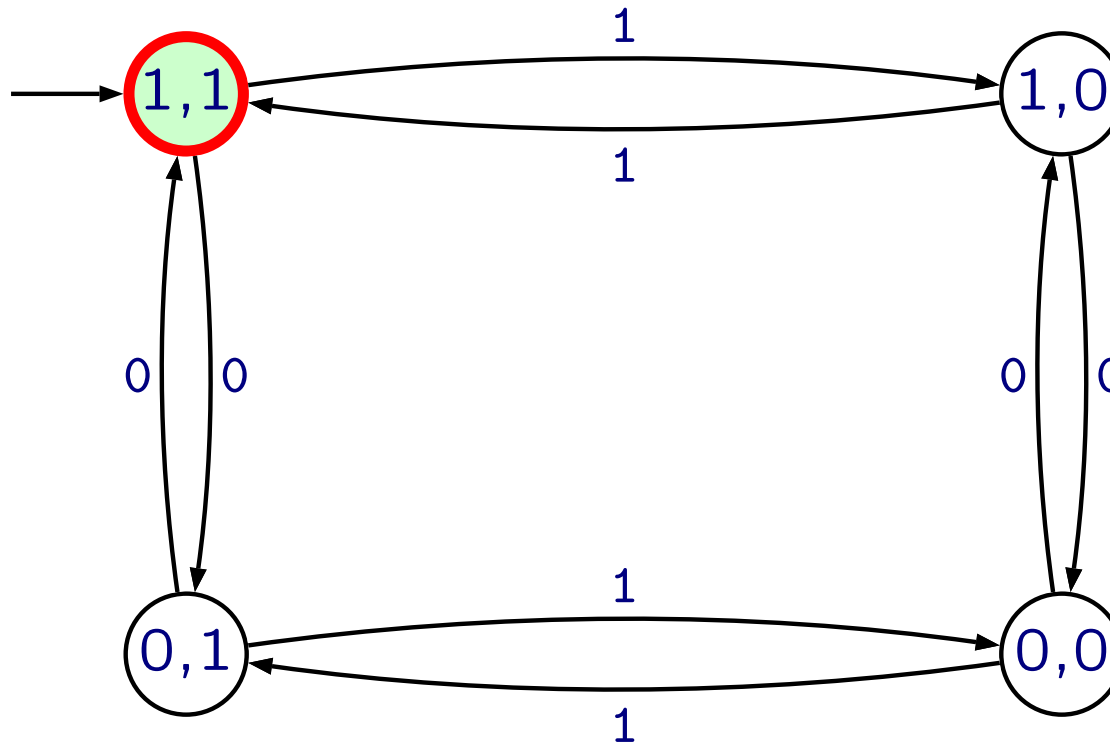

parity test



Akzeptieren

0

0

1

0

1

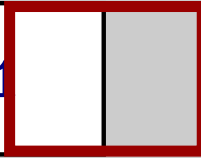

parity test

state transition graph

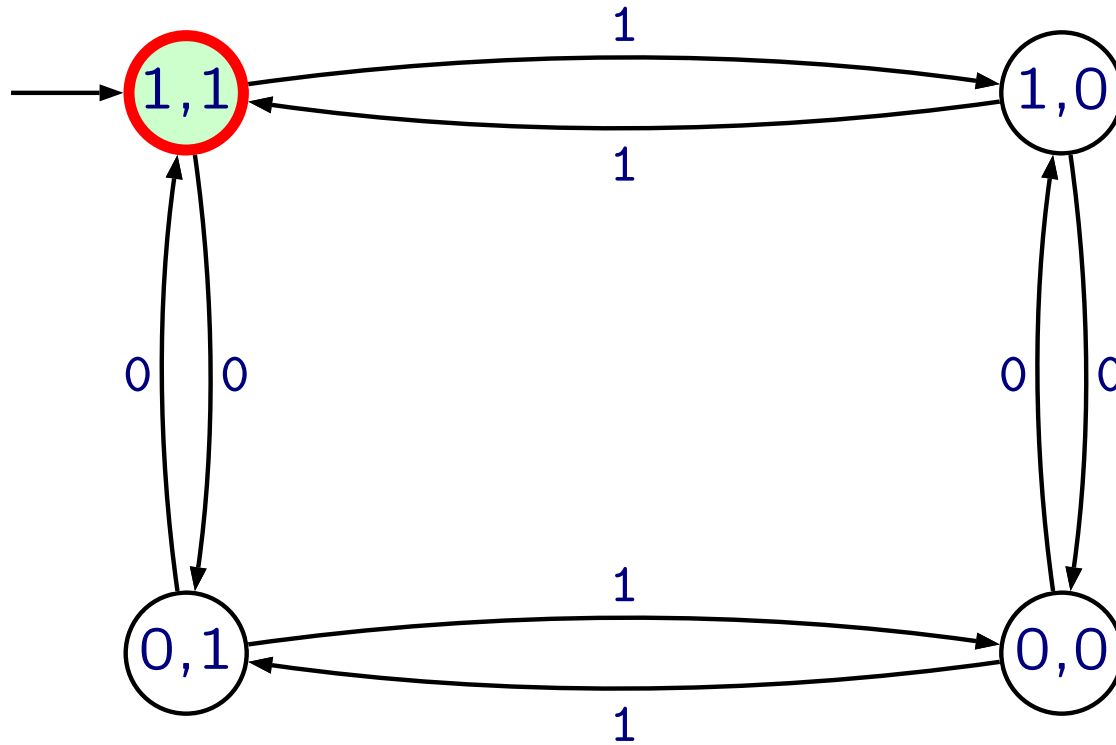

Akzeptieren

0

0

1

0

1

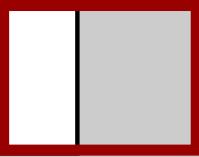

state transition graph

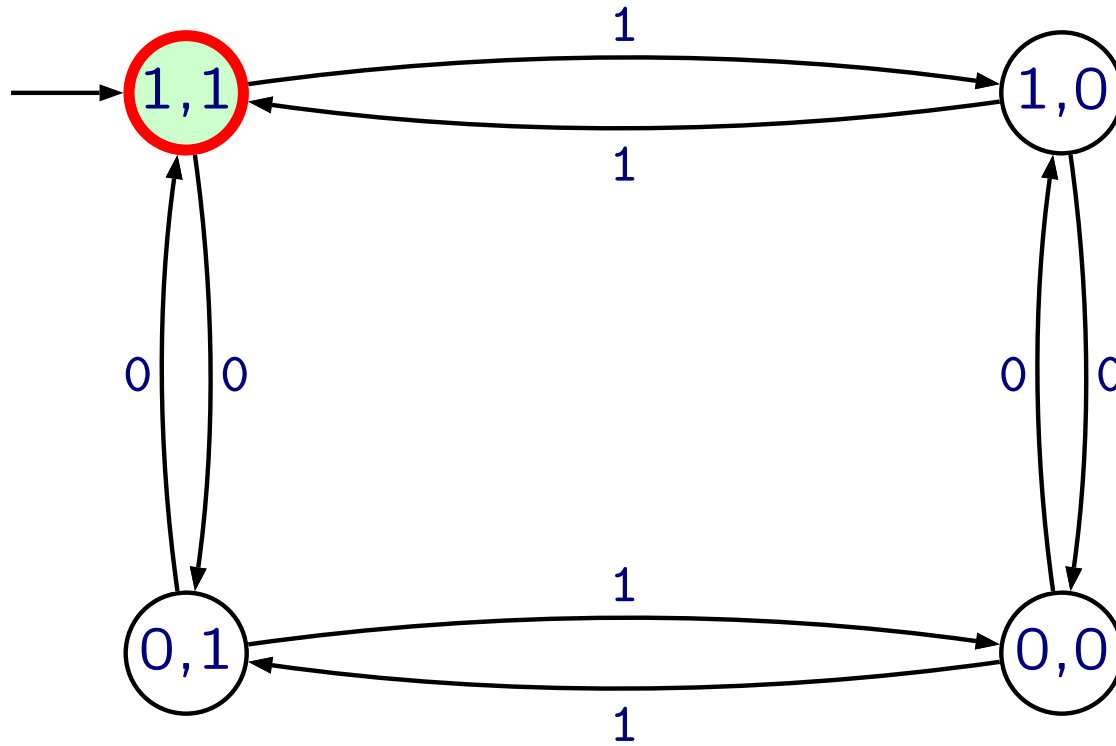

parity test



Akzeptieren

0

0

1

0

1

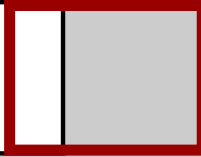

state transition graph

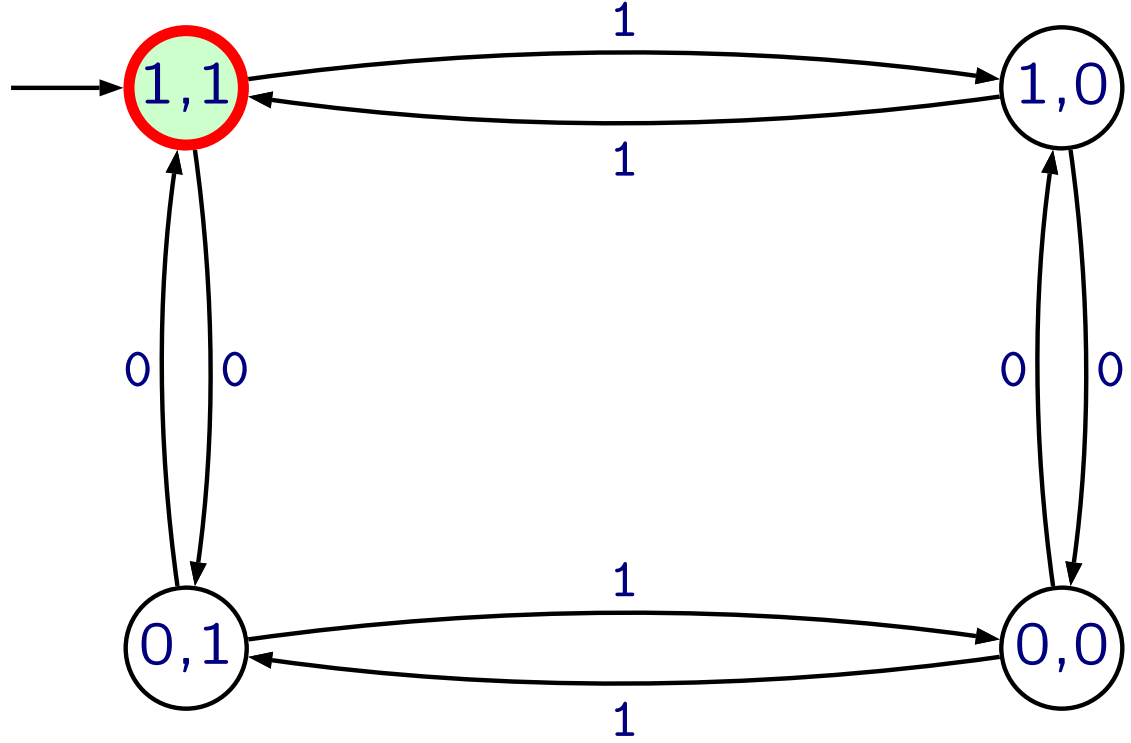

parity test



Akzeptieren

0

0

1

0

1



state transition graph

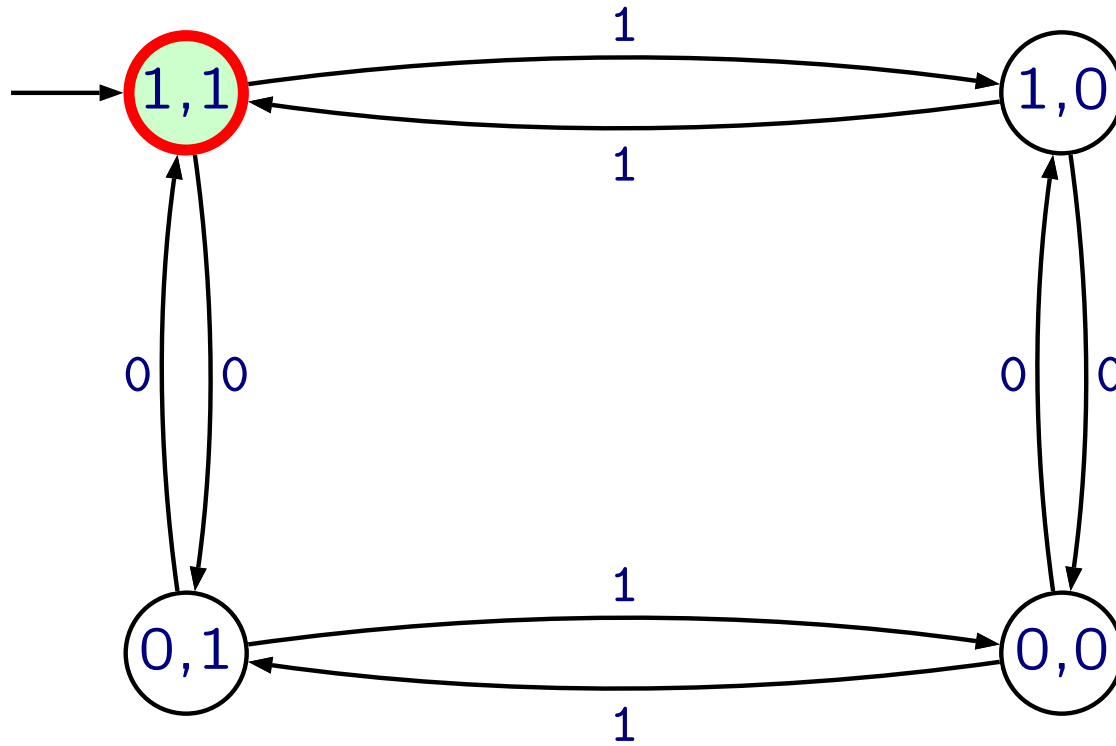

parity test



Akzeptieren

0

0

1

0

1



state transition graph

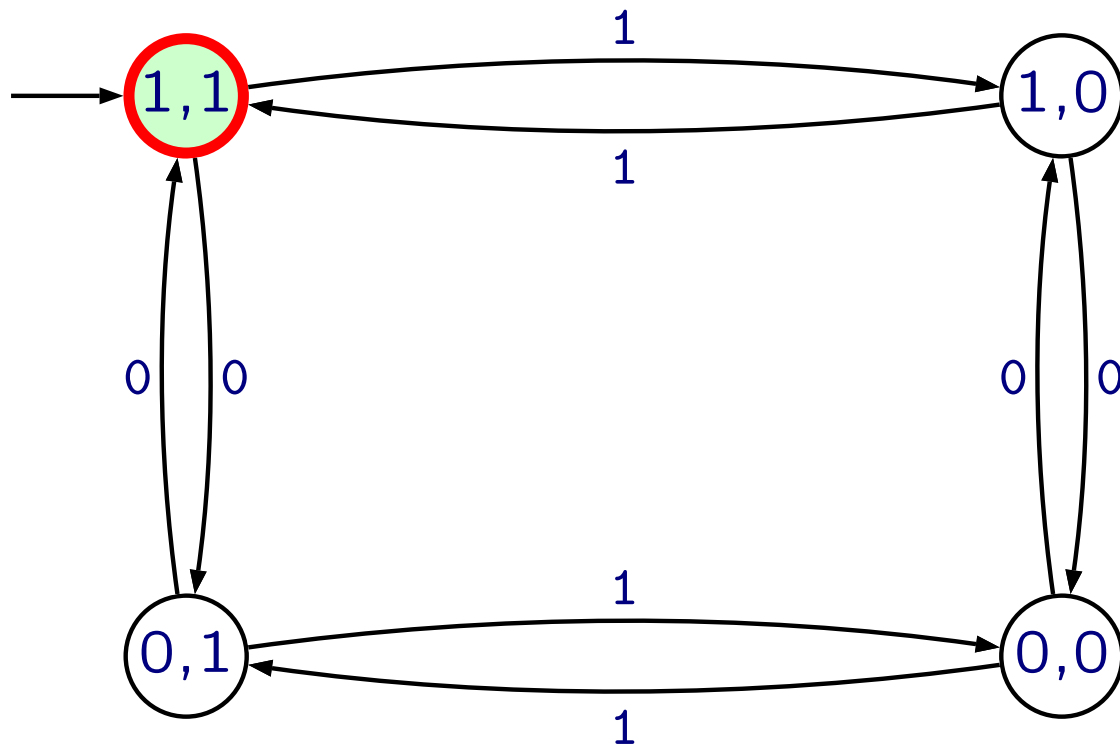

parity test



Akzeptieren

0

0

1

0

1



parity test

state transition graph

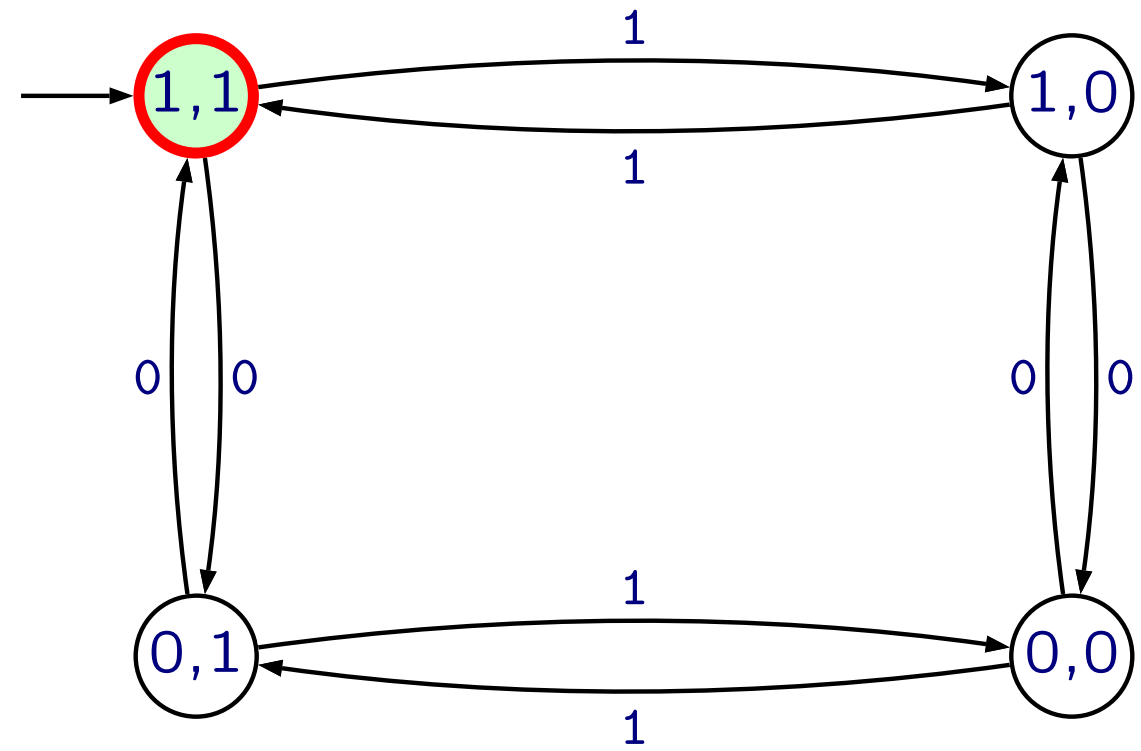

Akzeptieren

one bit serial adder

input tape

00

10

11

11

01

00

state transition graph

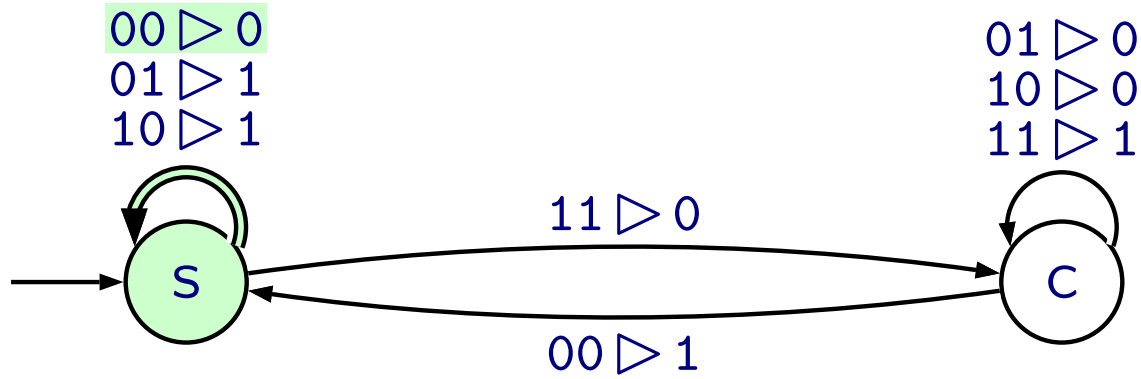

output tape

one bit serial adder

input tape

00

10

11

11

01

00

state transition graph

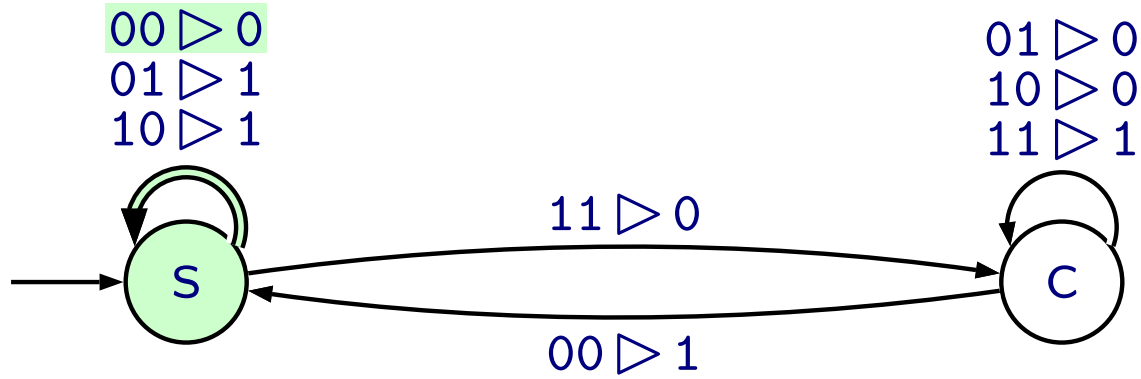

output tape

0

one bit serial adder

input tape

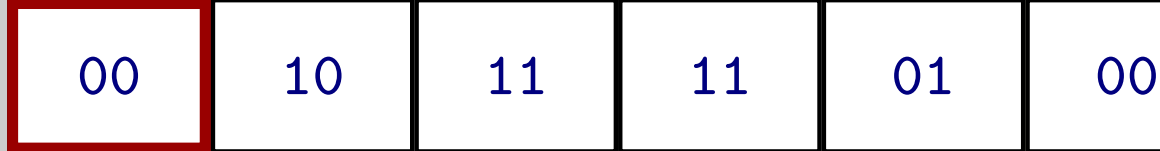

state transition graph

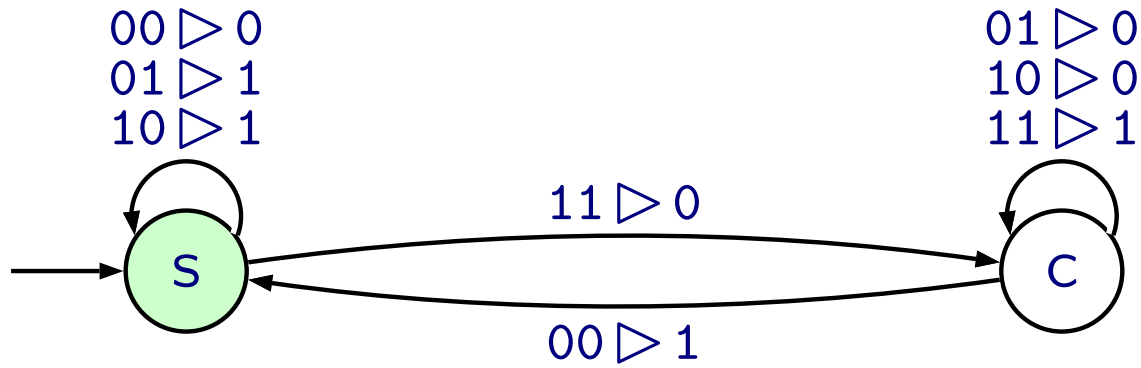

output tape



one bit serial adder

input tape

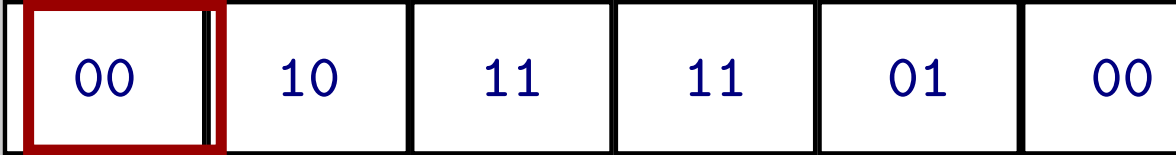

state transition graph

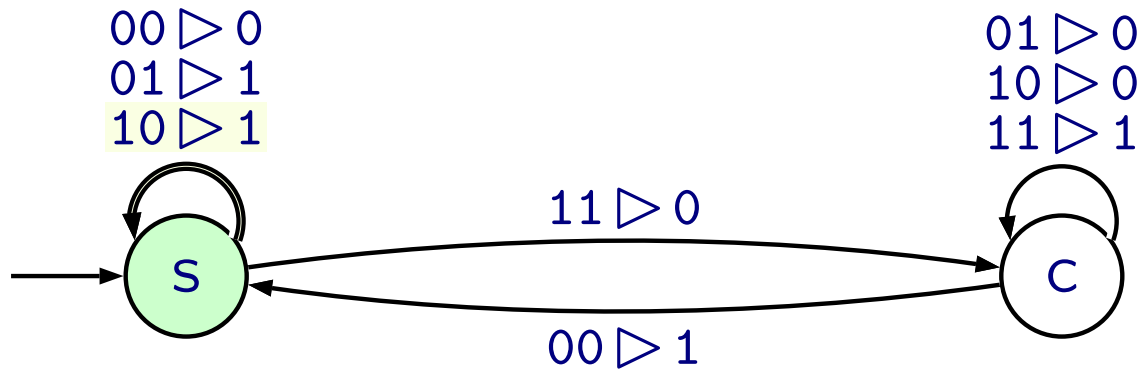

output tape



one bit serial adder

input tape

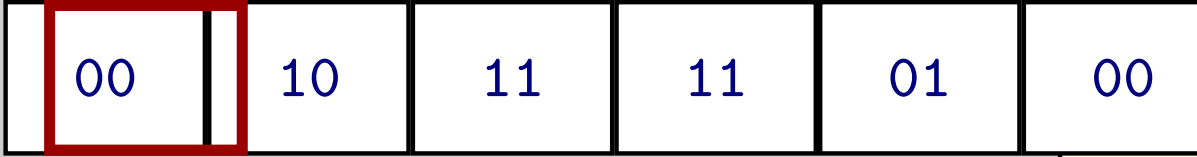

state transition graph

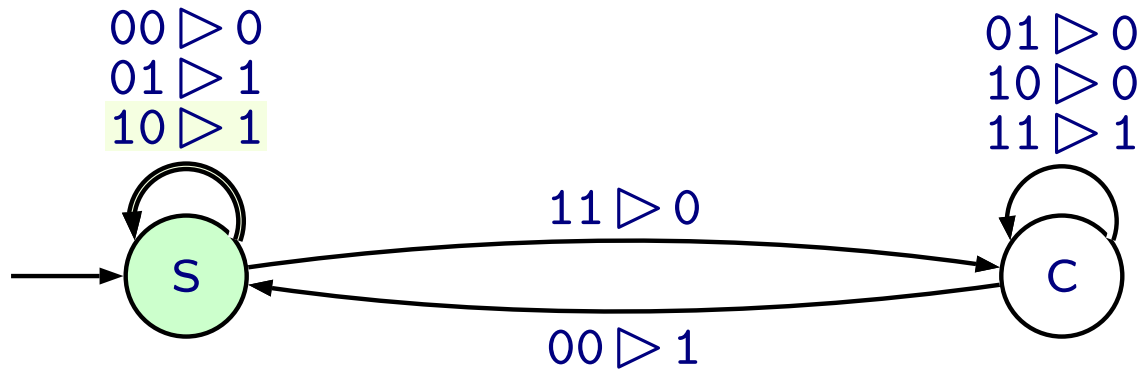

output tape



one bit serial adder

input tape



state transition graph

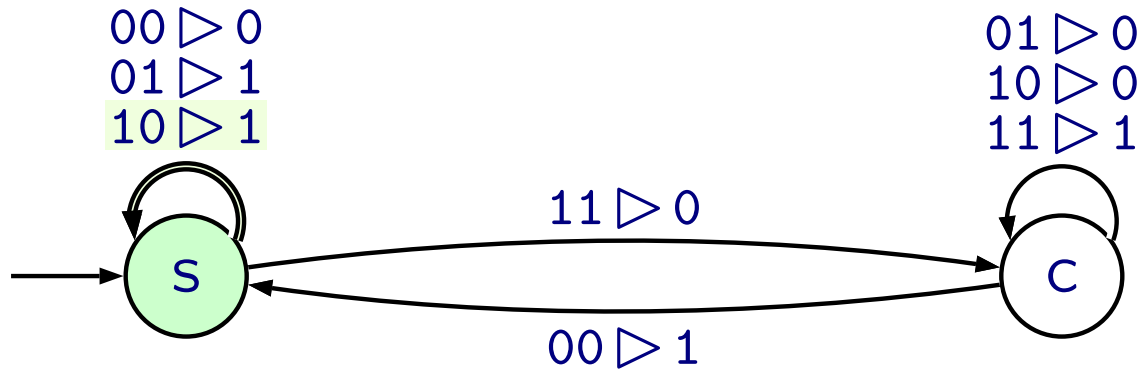

output tape



one bit serial adder

input tape

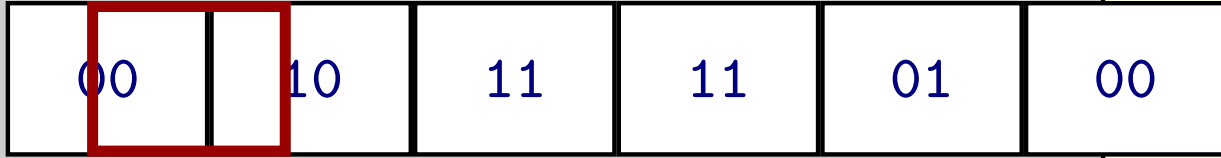

state transition graph

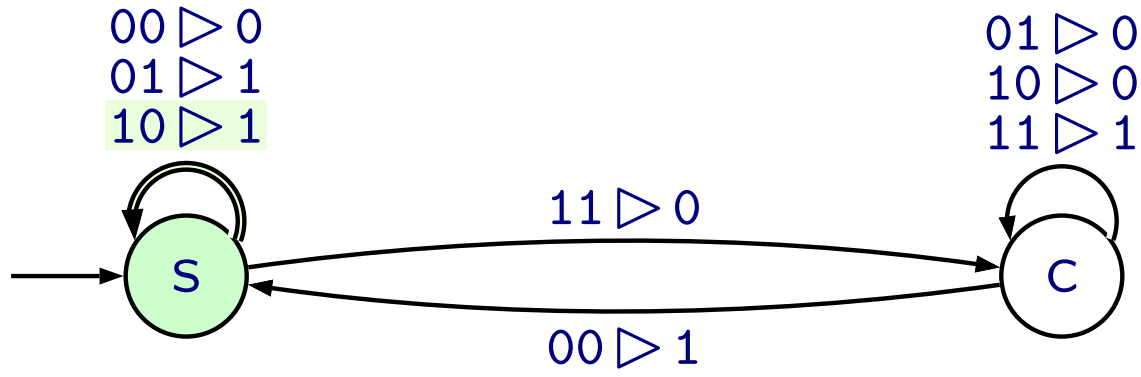

output tape



one bit serial adder

input tape

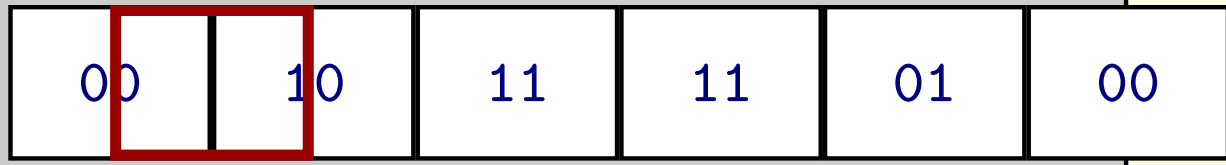

state transition graph

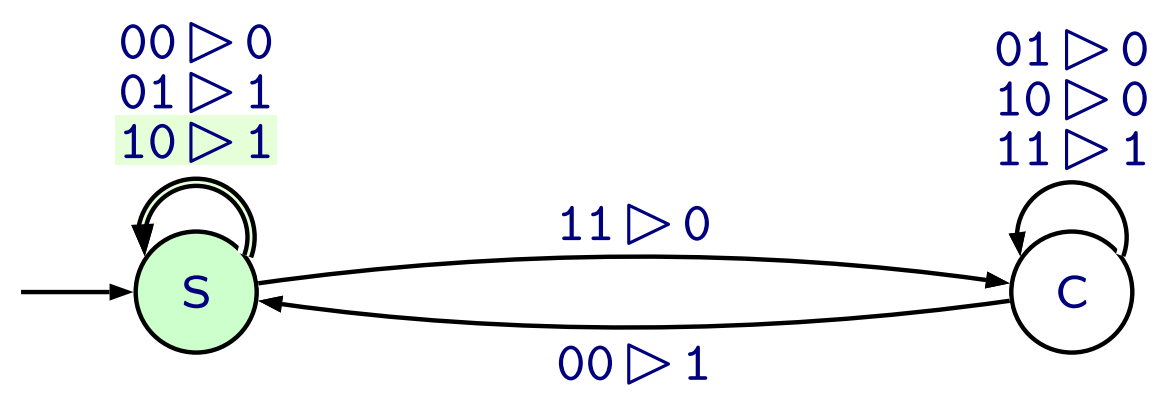

output tape



one bit serial adder

input tape



state transition graph

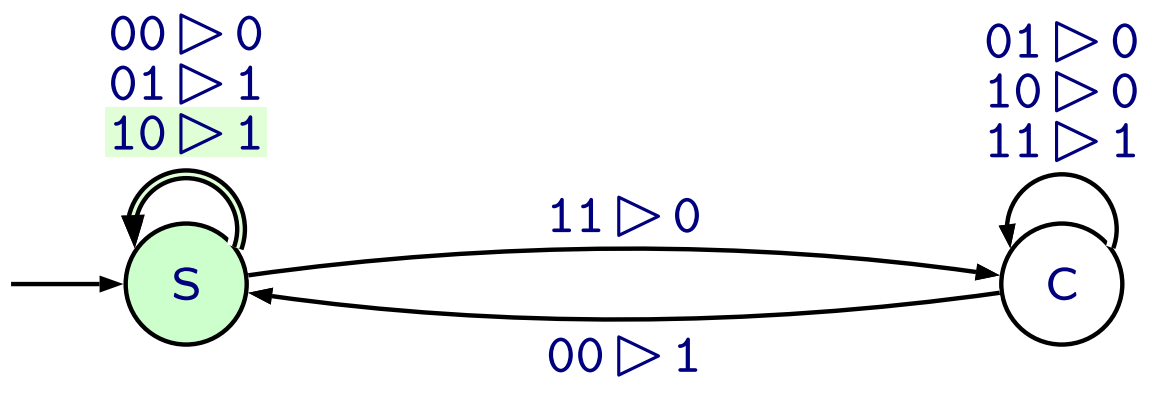

output tape



one bit serial adder

input tape

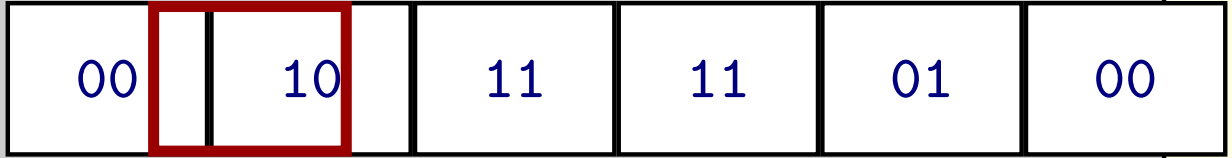

state transition graph

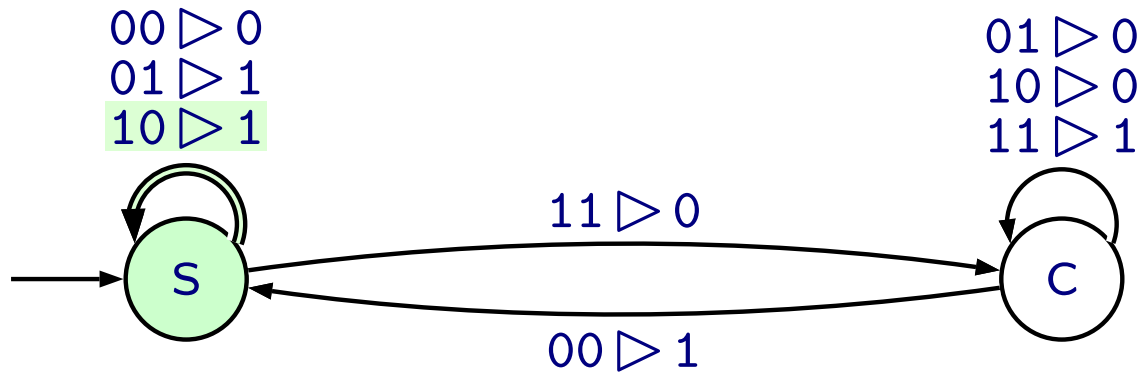

output tape

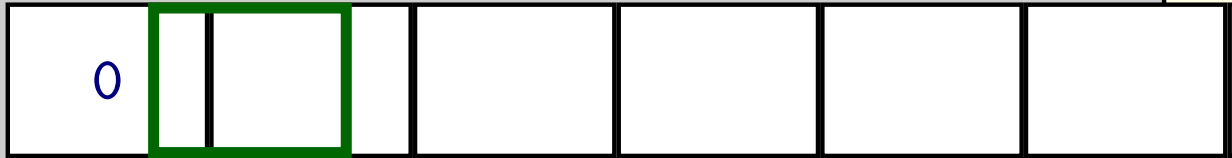

one bit serial adder

input tape

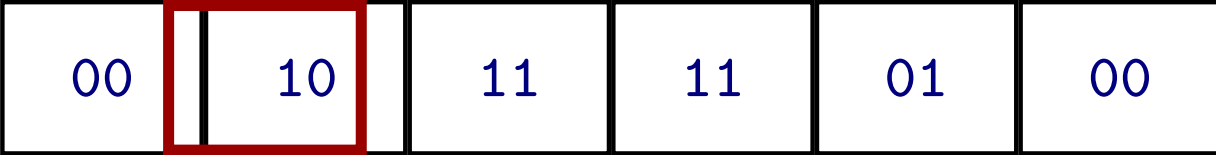

state transition graph

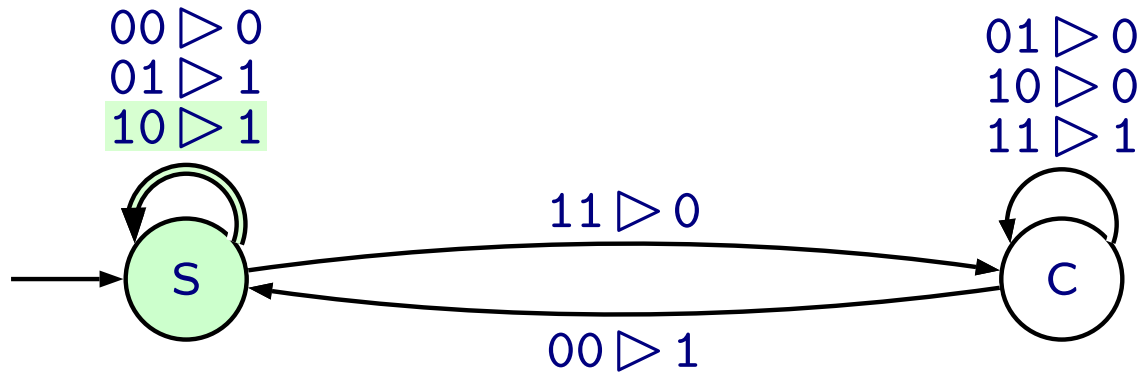

output tape

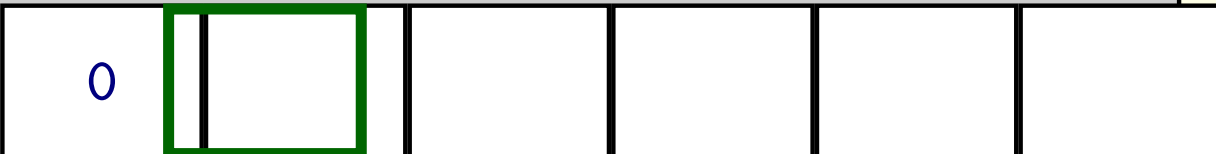

one bit serial adder

input tape

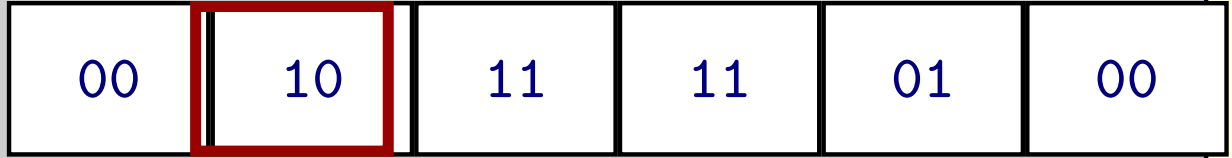

state transition graph

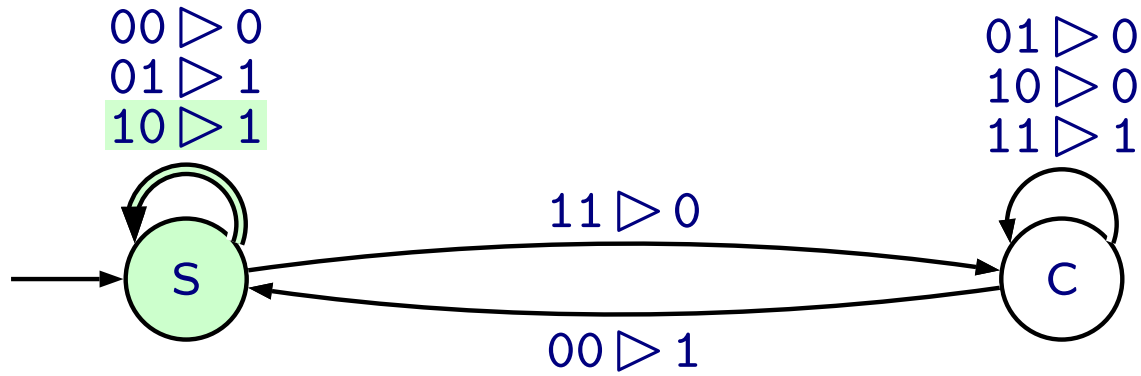

output tape

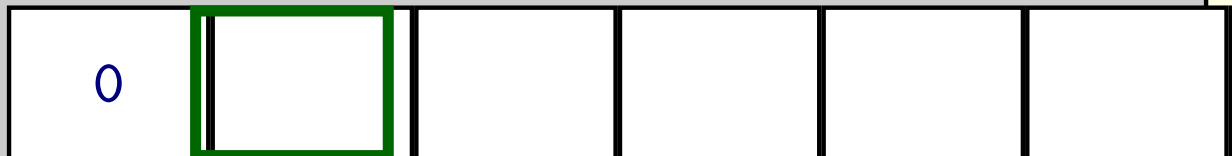

one bit serial adder

input tape

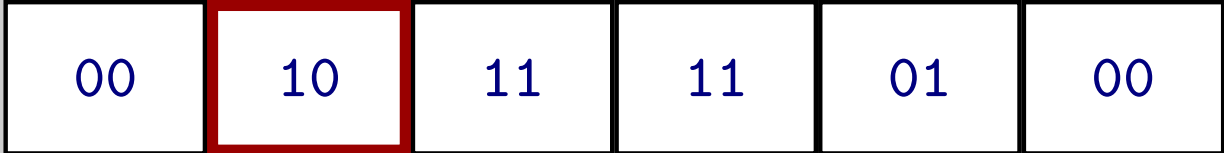

state transition graph

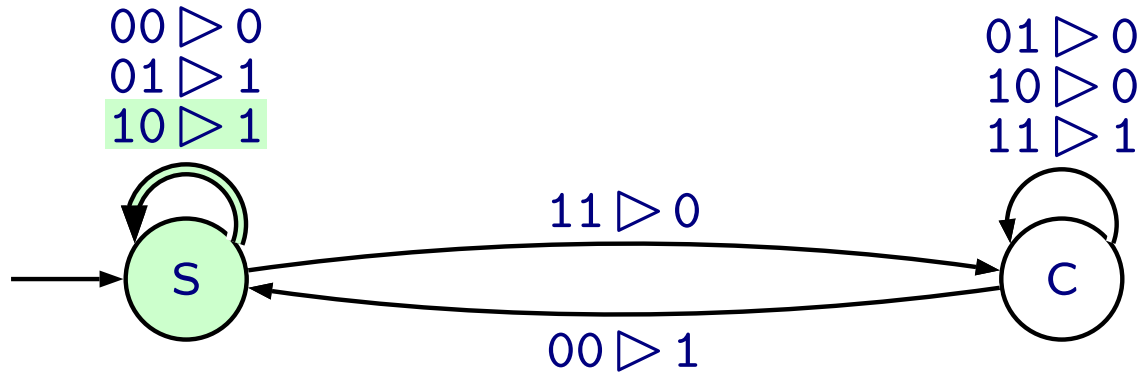

output tape

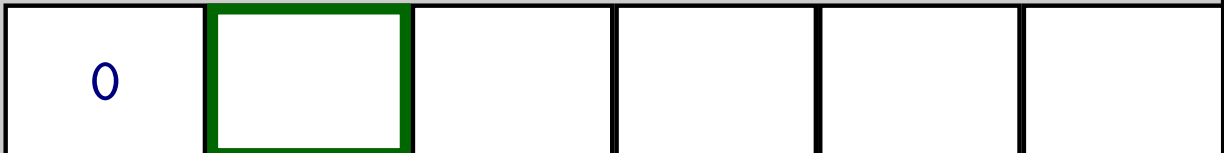

one bit serial adder

input tape

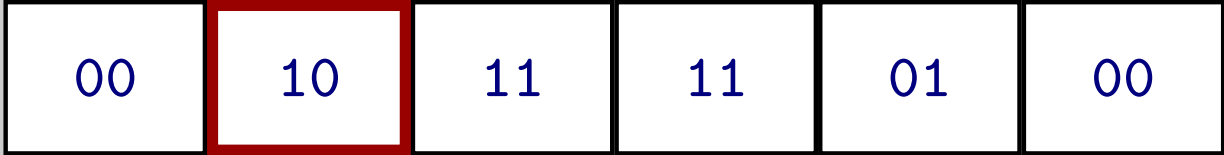

state transition graph

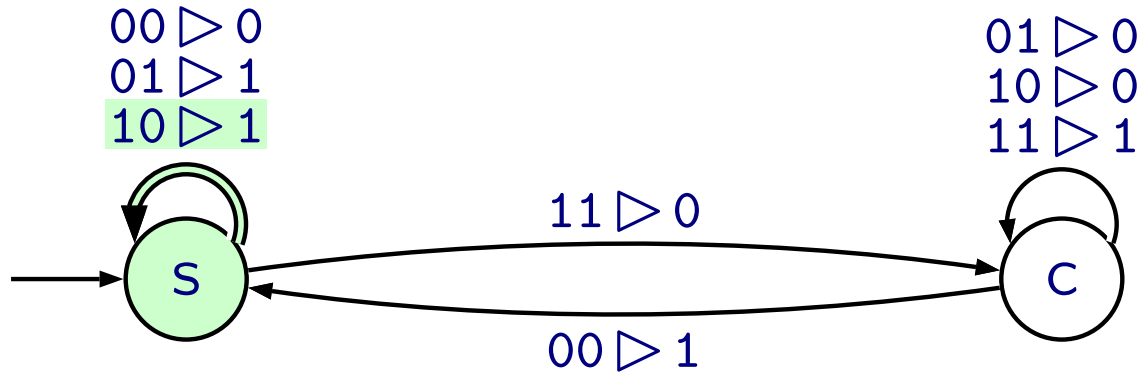

output tape

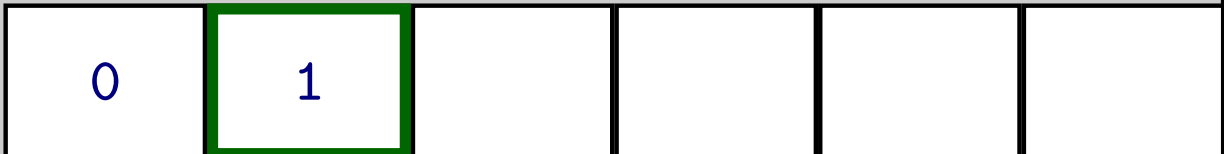

one bit serial adder

input tape

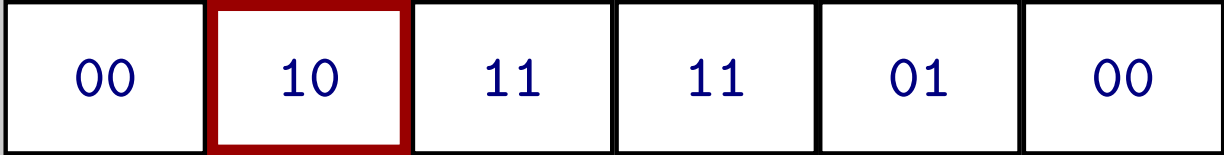

state transition graph

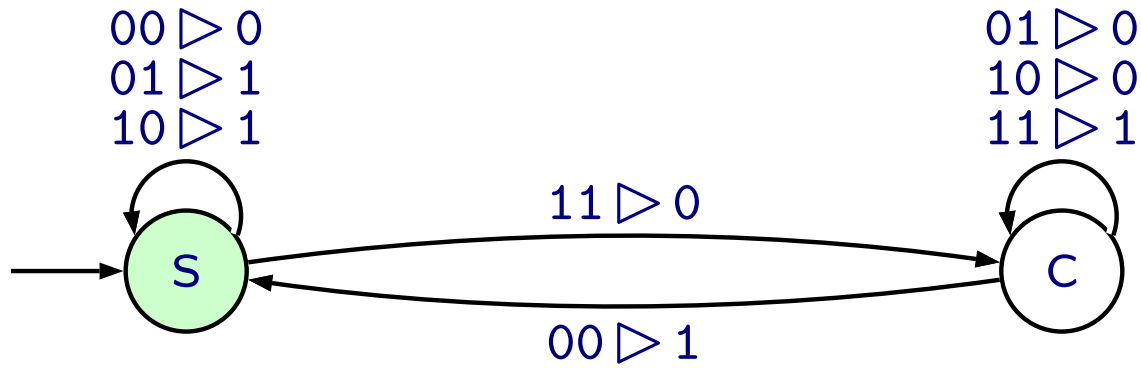

output tape

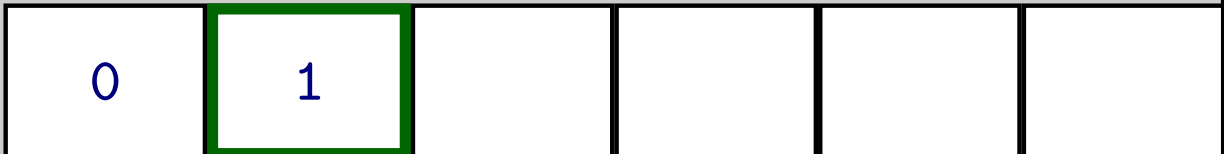

one bit serial adder

input tape

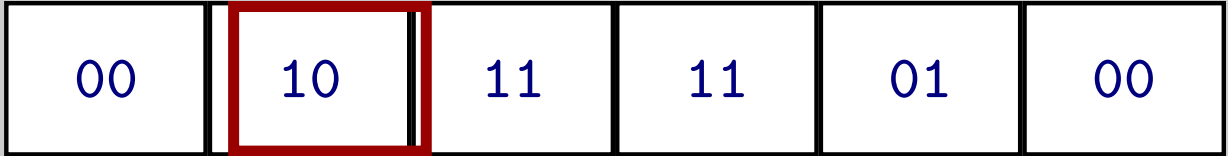

state transition graph

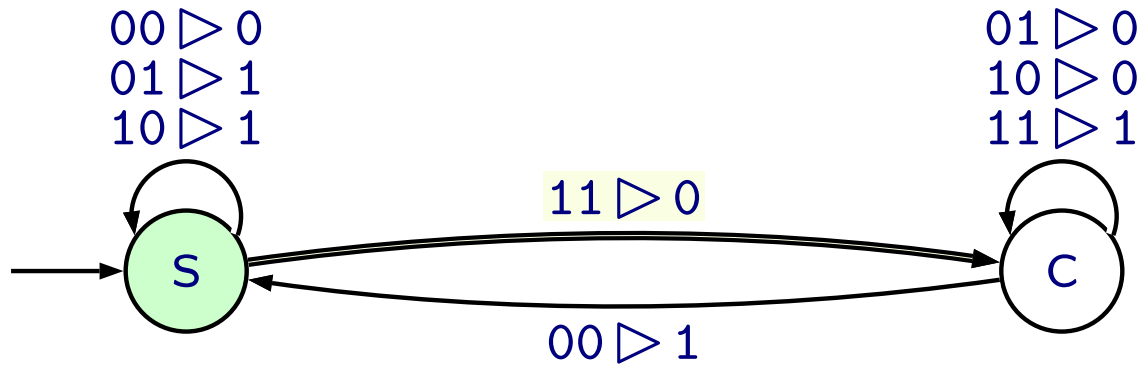

output tape

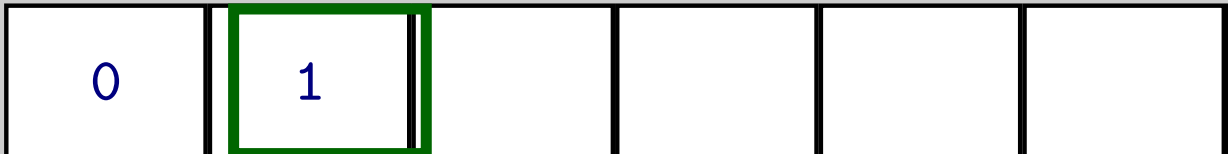

one bit serial adder

input tape

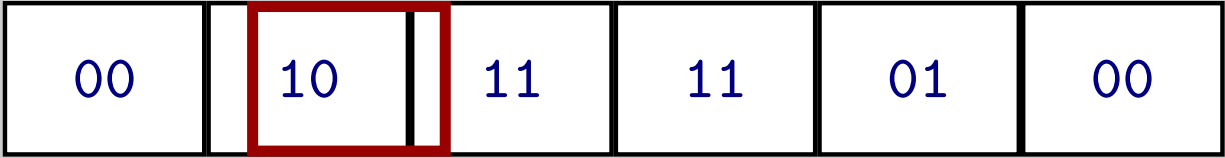

state transition graph

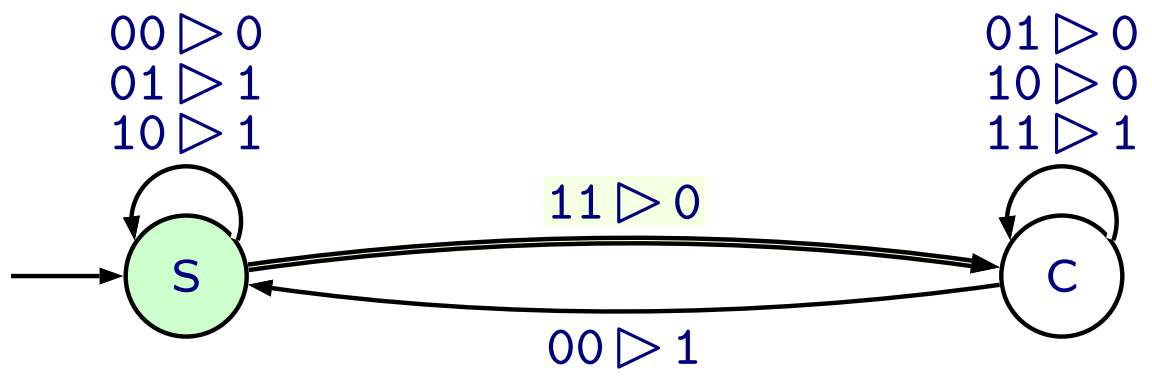

output tape

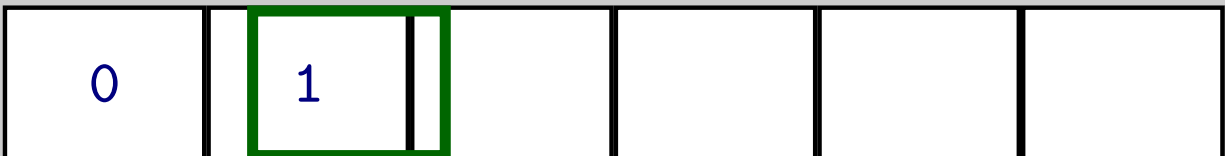

one bit serial adder

input tape

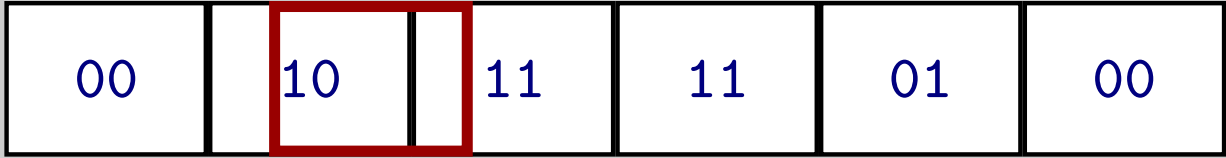

state transition graph

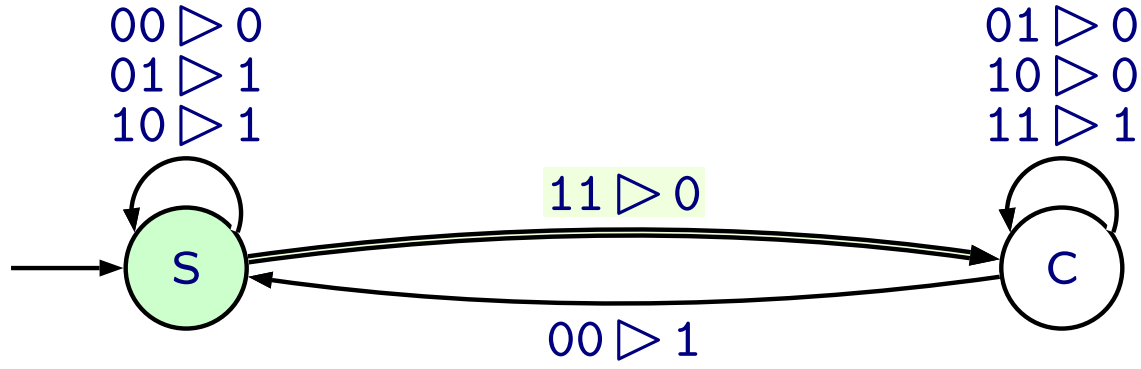

output tape



one bit serial adder

input tape

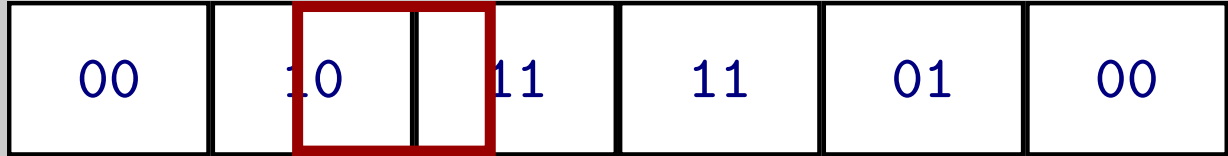

state transition graph

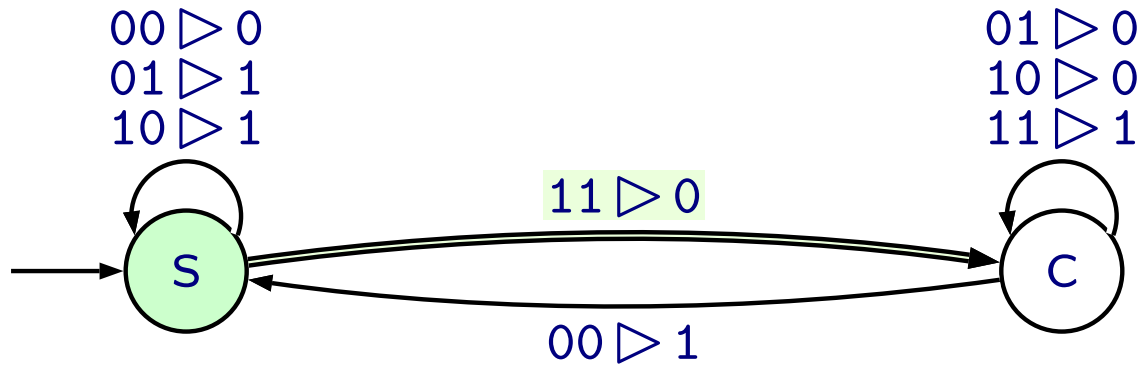

output tape



one bit serial adder

input tape

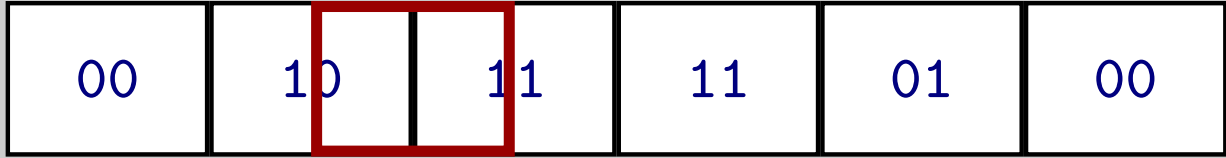

state transition graph

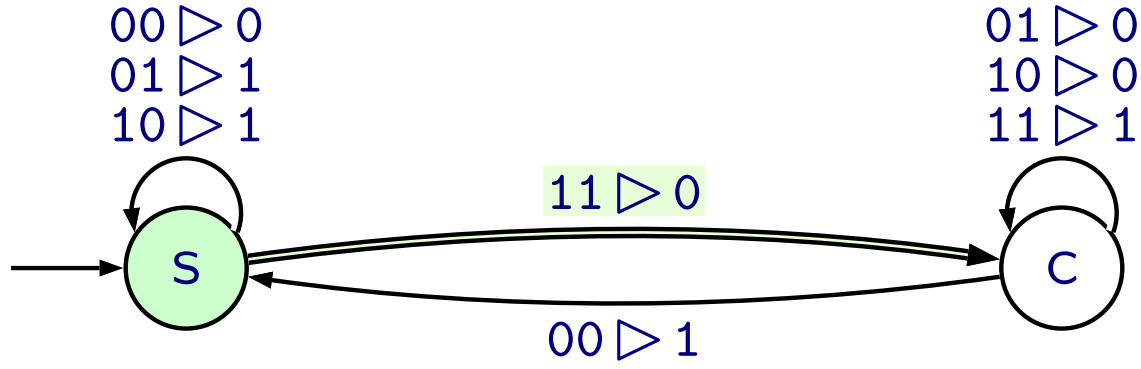

output tape



one bit serial adder

input tape

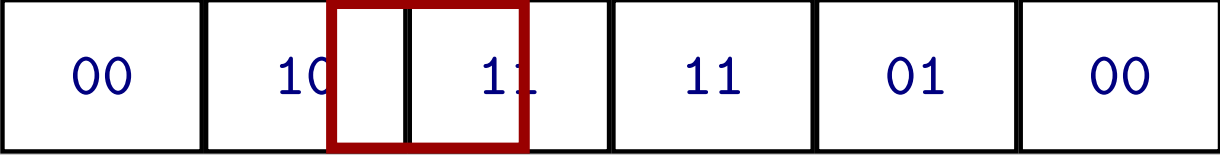

state transition graph

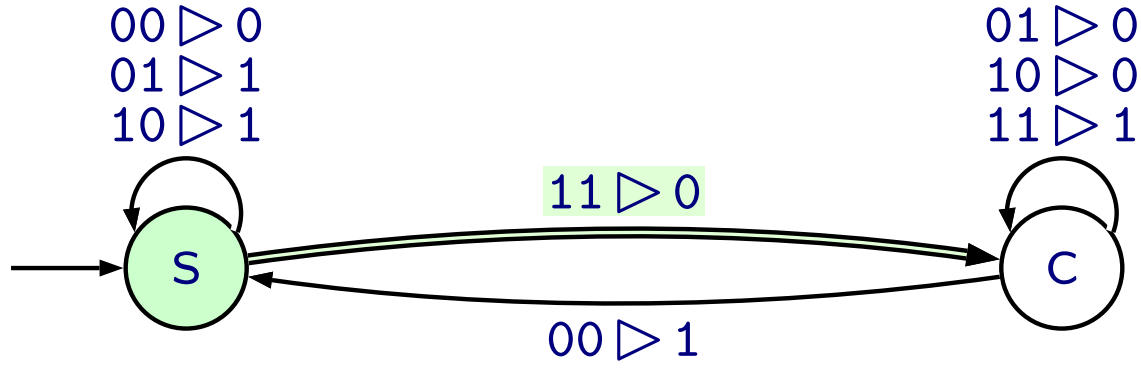

output tape

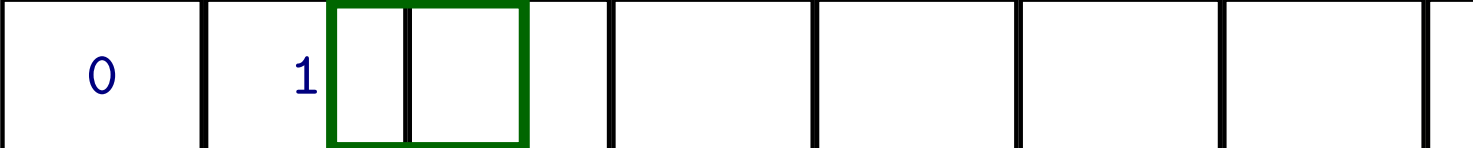

one bit serial adder

input tape

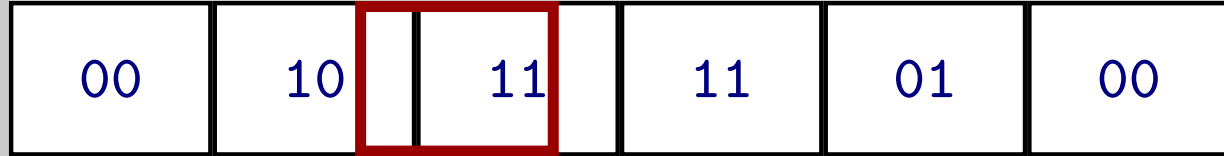

state transition graph

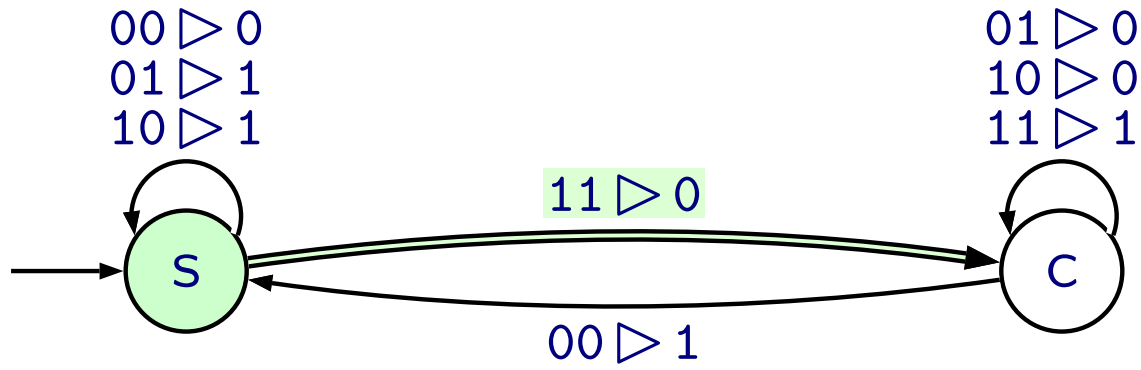

output tape



one bit serial adder

input tape

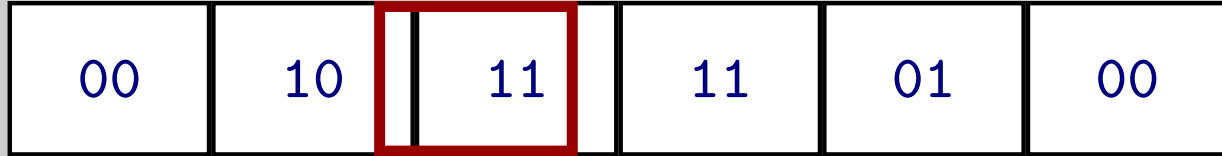

state transition graph

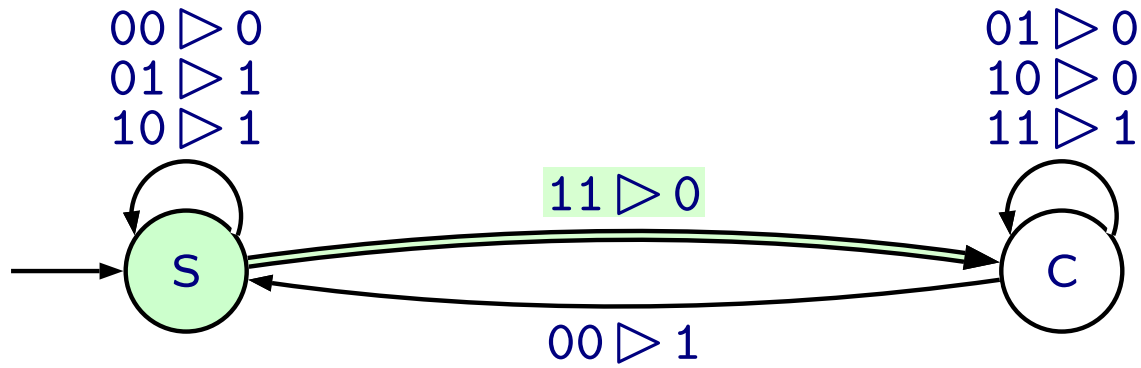

output tape



one bit serial adder

input tape

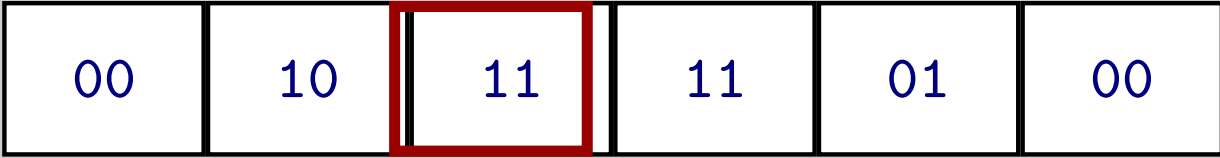

state transition graph

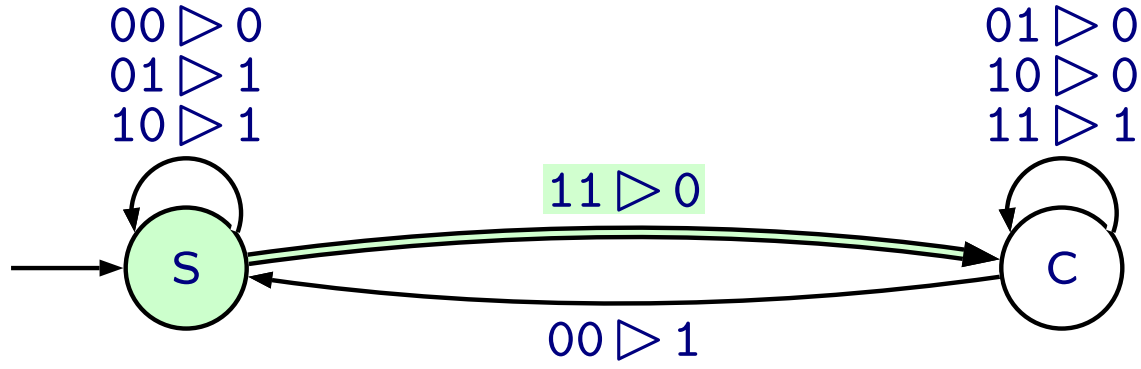

output tape



one bit serial adder

input tape

00

10

11

11

01

00

state transition graph

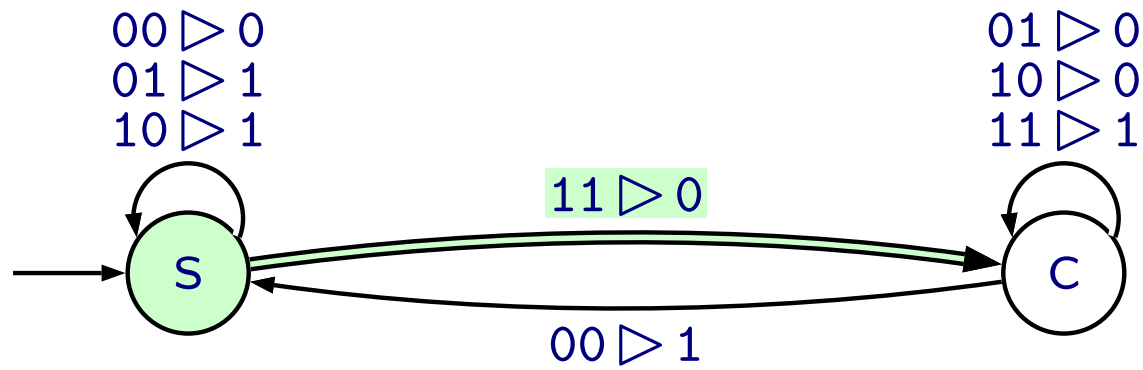

output tape

0

1

one bit serial adder

input tape

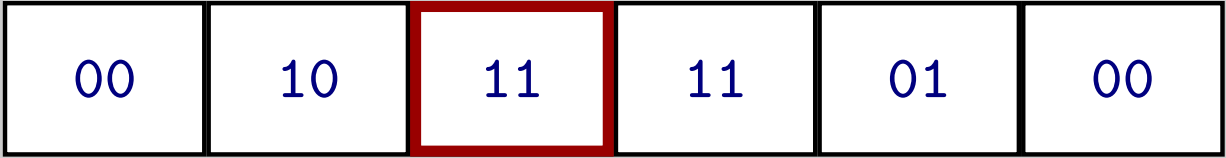

state transition graph

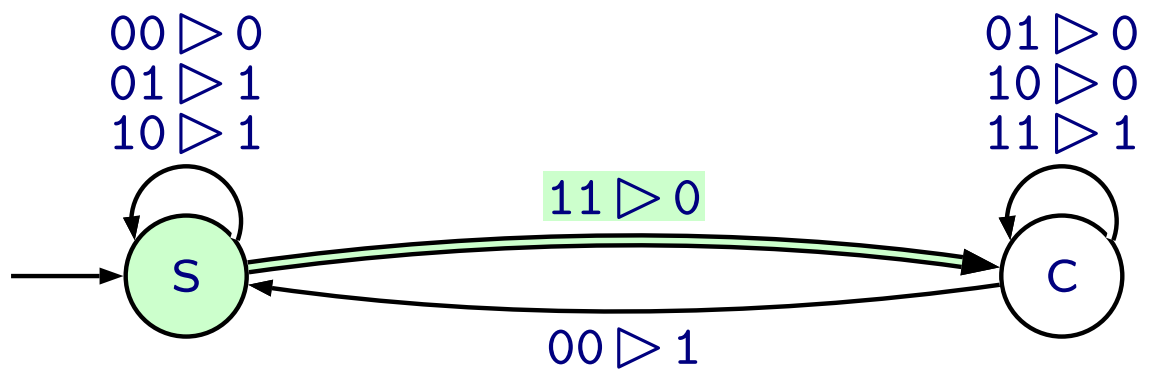

output tape



one bit serial adder

input tape

00

10

11

11

01

00

state transition graph

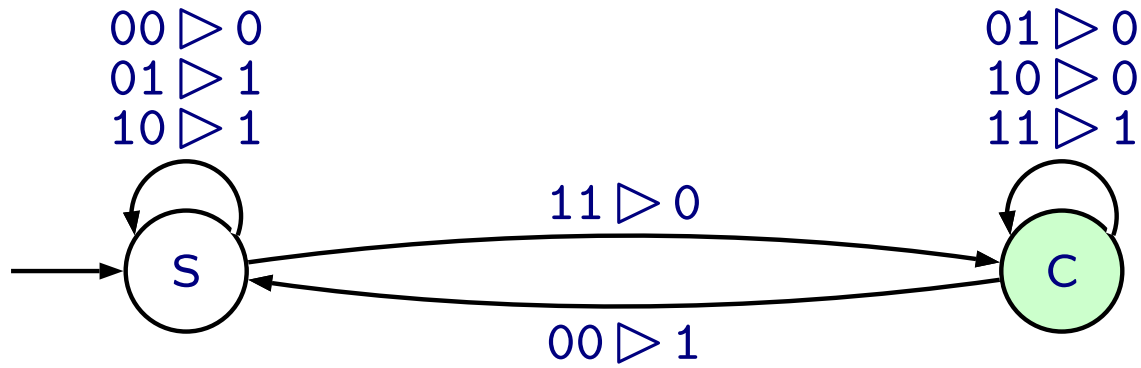

output tape

0

1

0

one bit serial adder

input tape

00

10

11

11

01

00

state transition graph

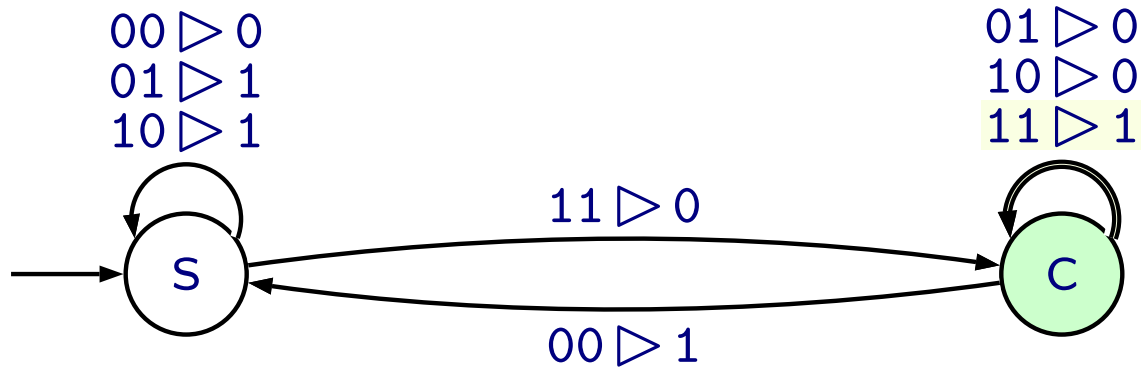

output tap

0

1

0

one bit serial adder

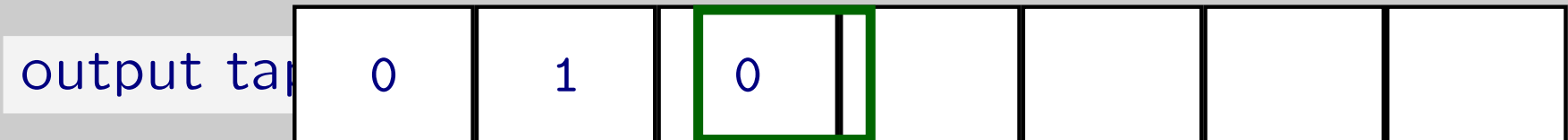
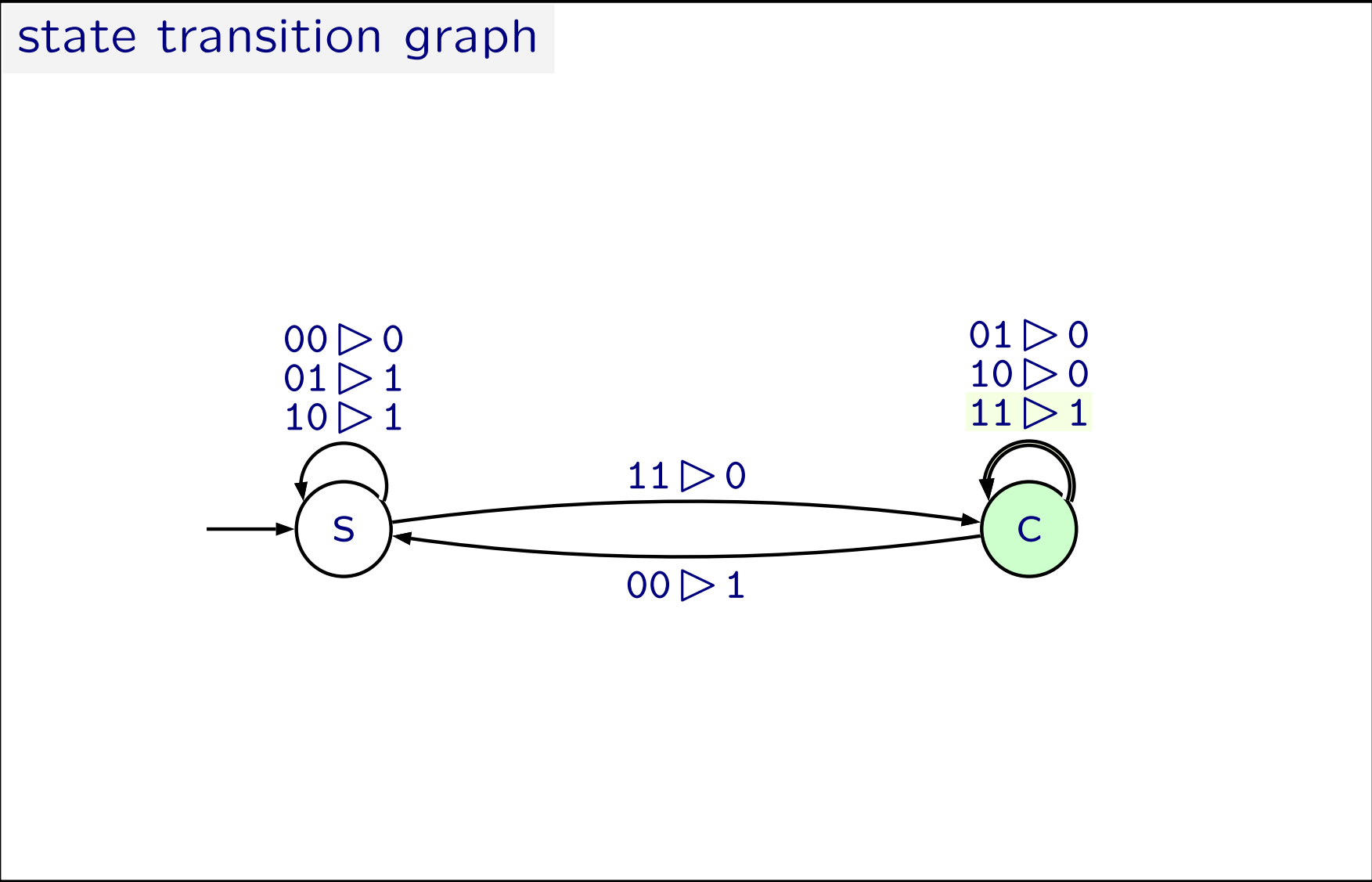
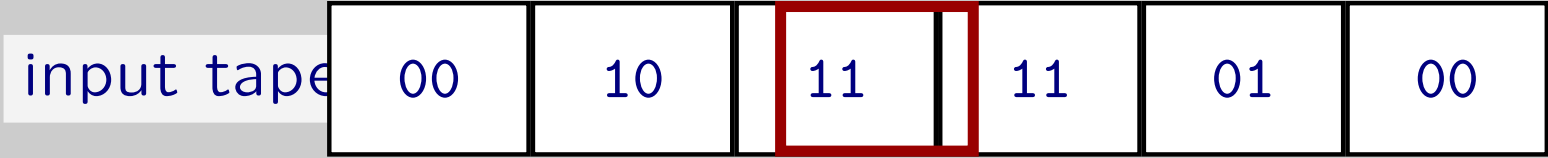

one bit serial adder

input tap

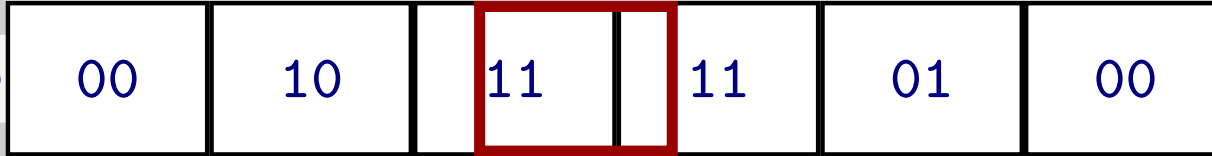

state transition graph

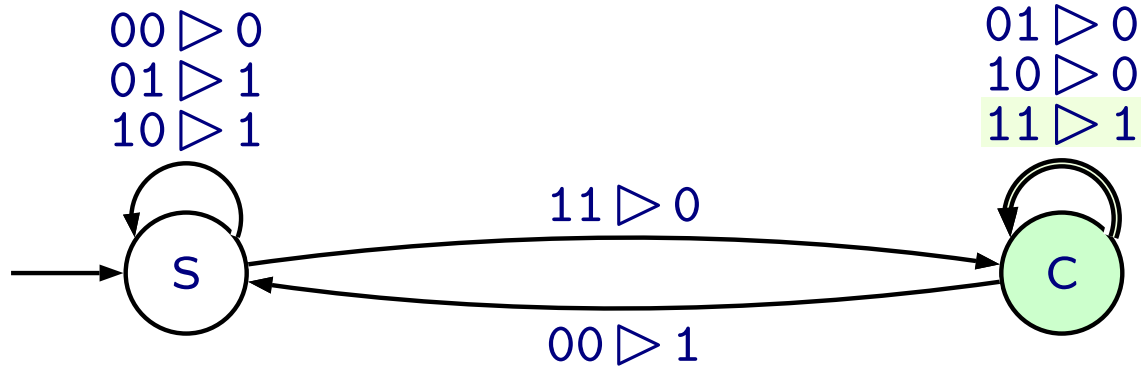

output tap

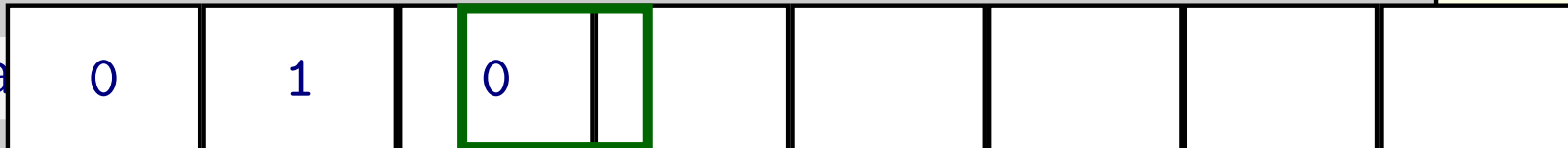

one bit serial adder

input tap 00 10 11 11 01 00

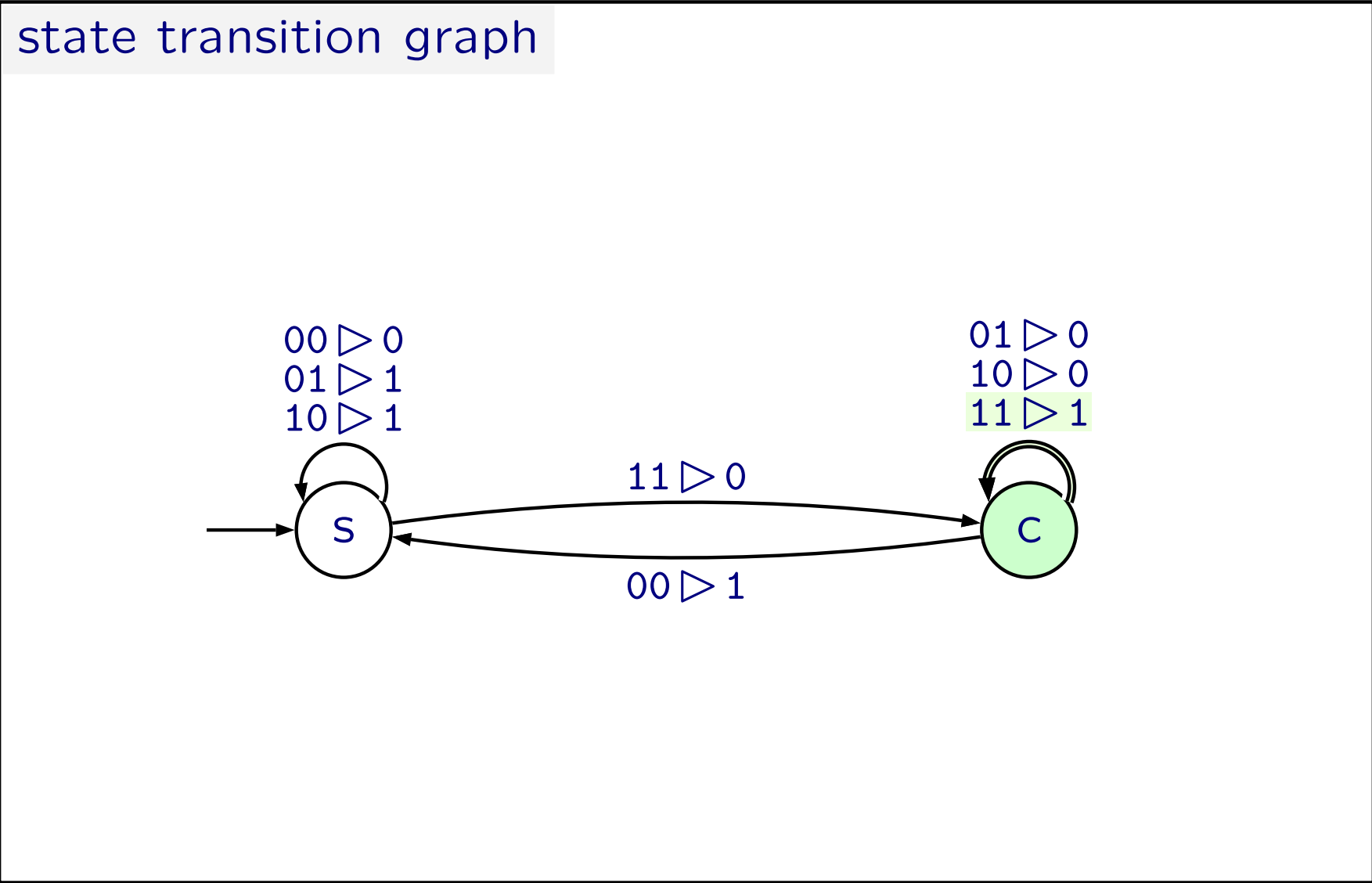

output tap 0 1 0

one bit serial adder

input ta 00 10 11 11 01 00

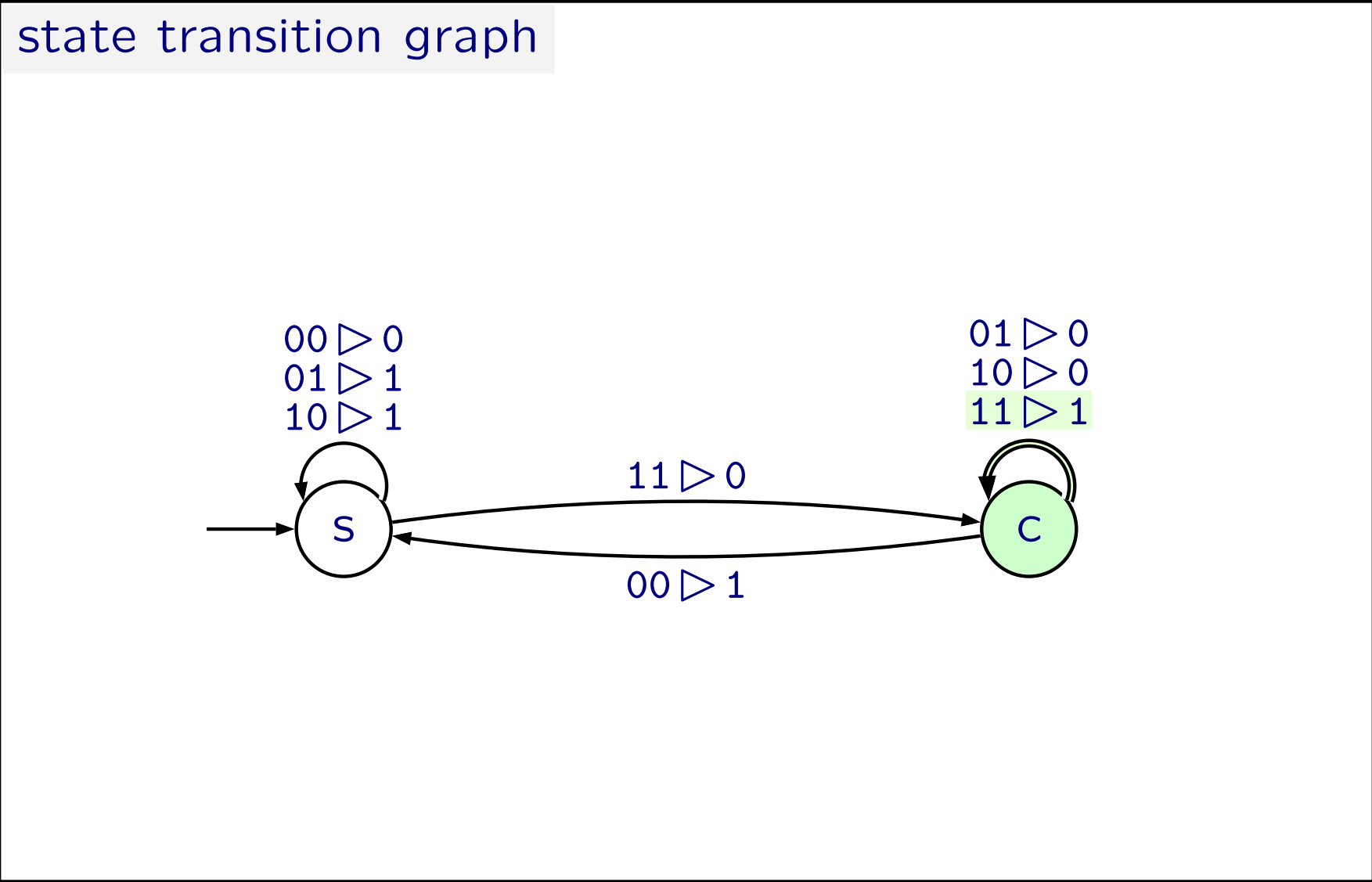

output t 0 1 0 1

one bit serial adder

input ta 00 10 11 11 01 00

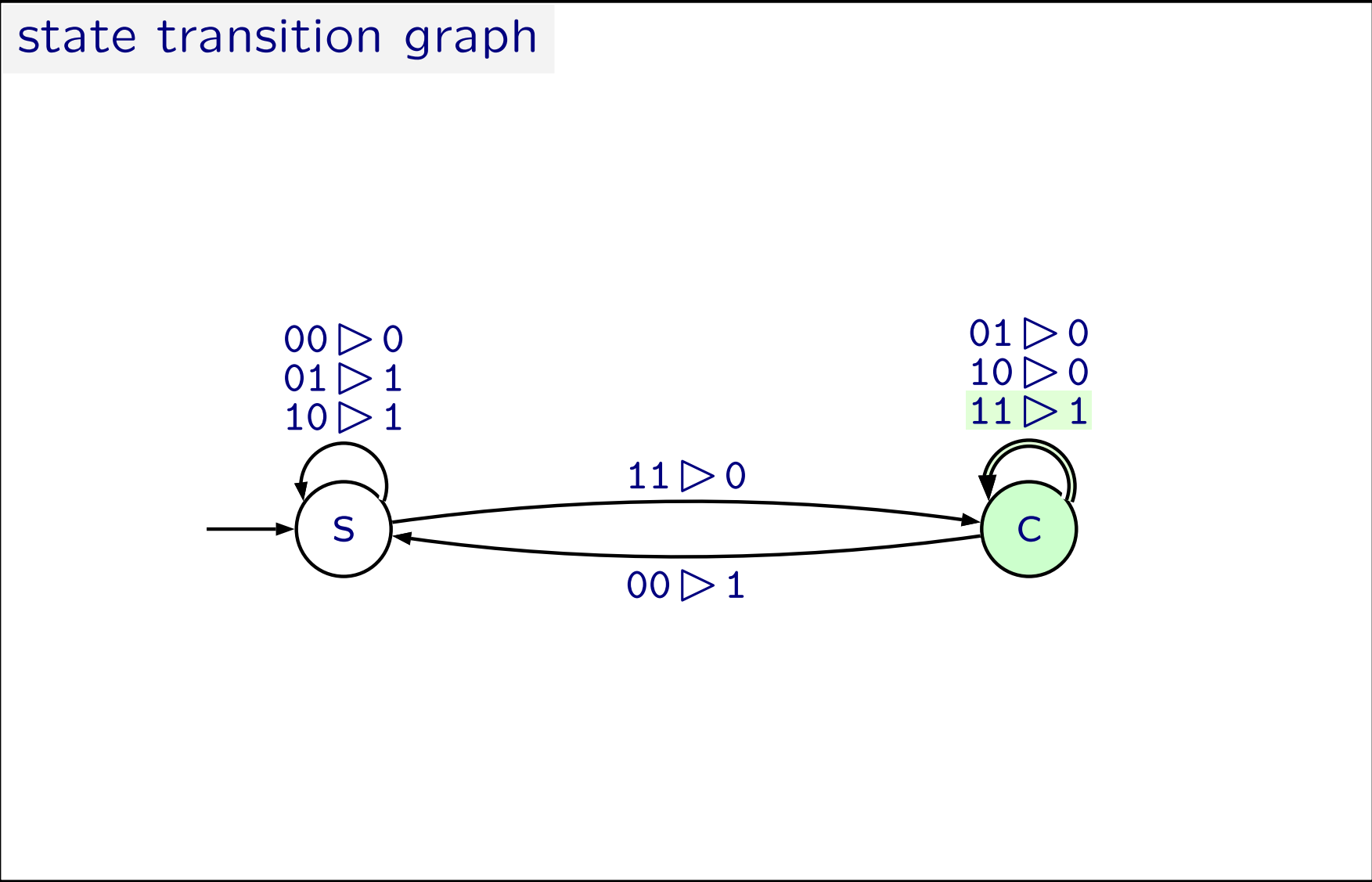

output 0 1 0 0 0 0 0 0 0 0

one bit serial adder

input t 00 10 11 11 01 00

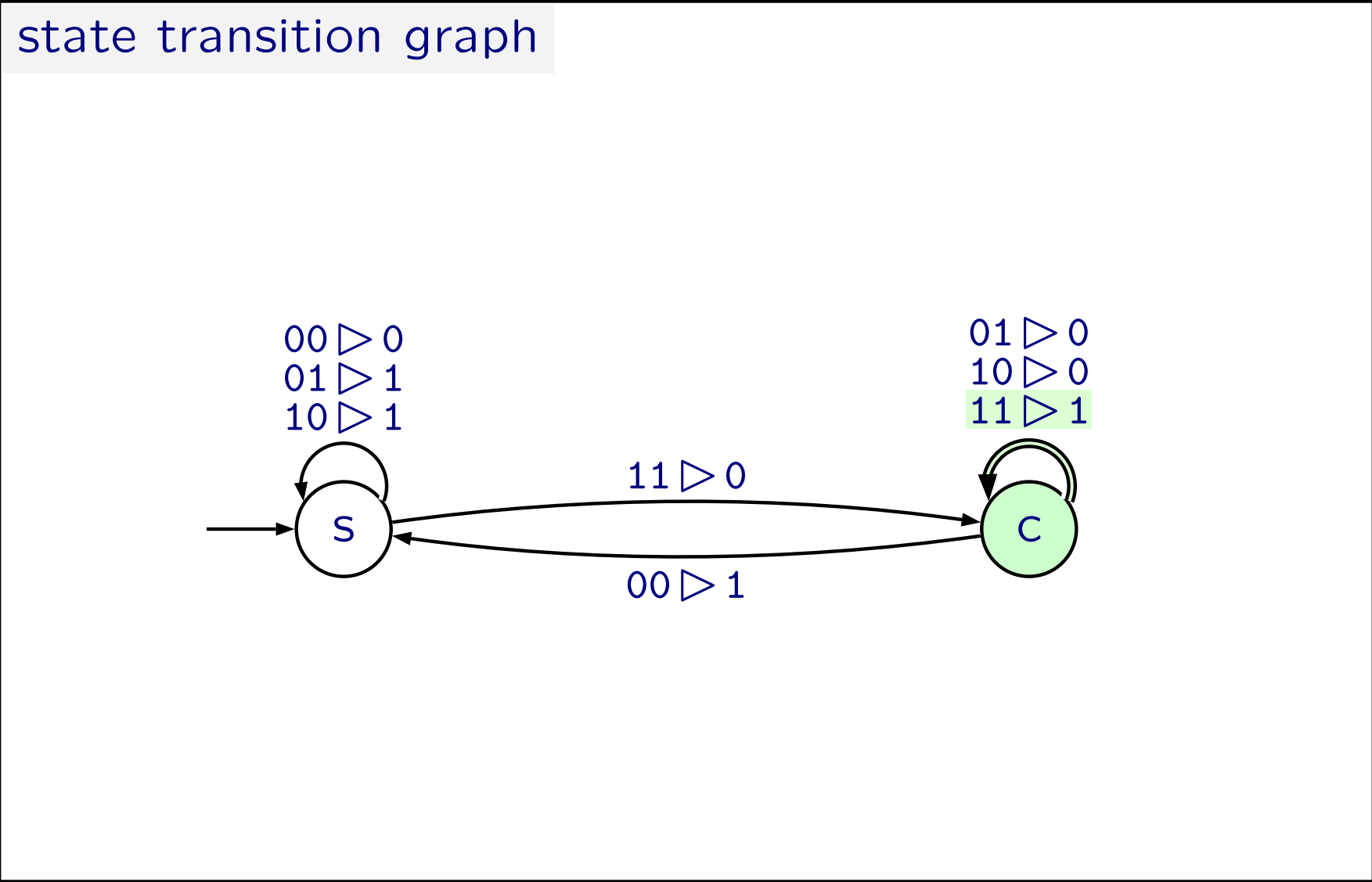

output 0 1 0 1 1 1 1 1 1 1 1 1

one bit serial adder

input 00 10 11 11 01 00

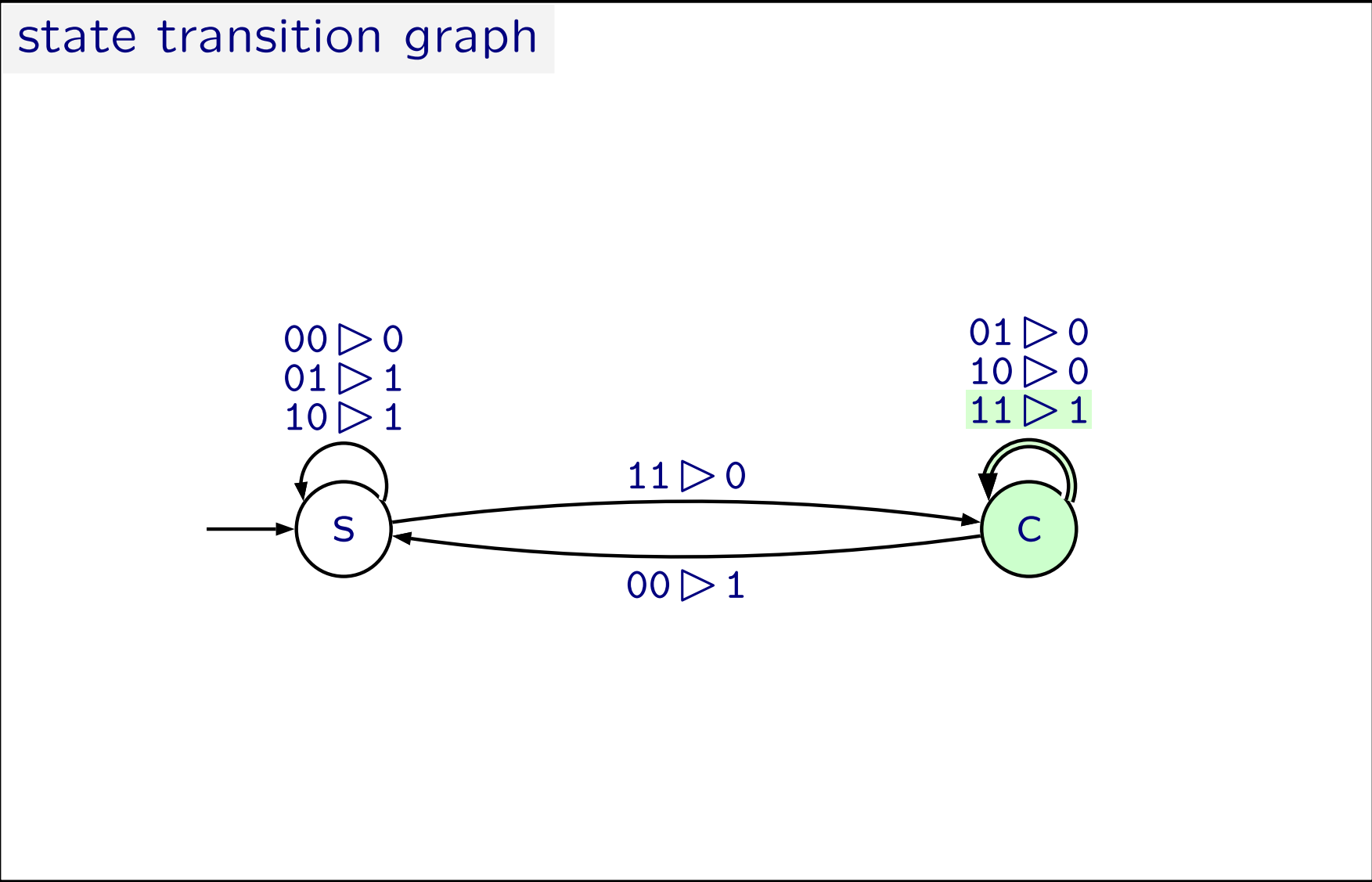

output 0 1 0 1

one bit serial adder

input 00 10 11 11 01 00

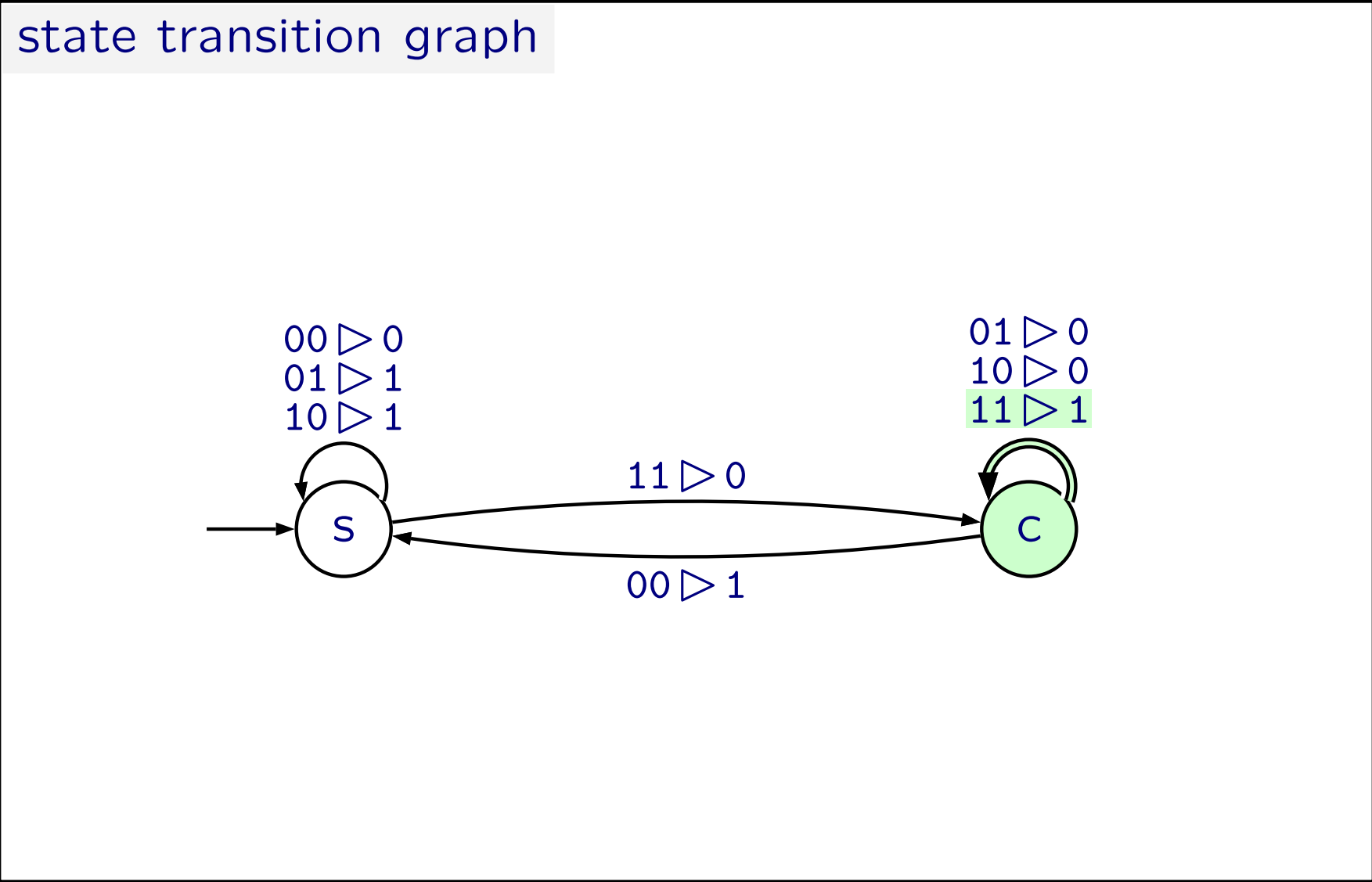

output 0 1 0

one bit serial adder

input 00 10 11 11 01 00

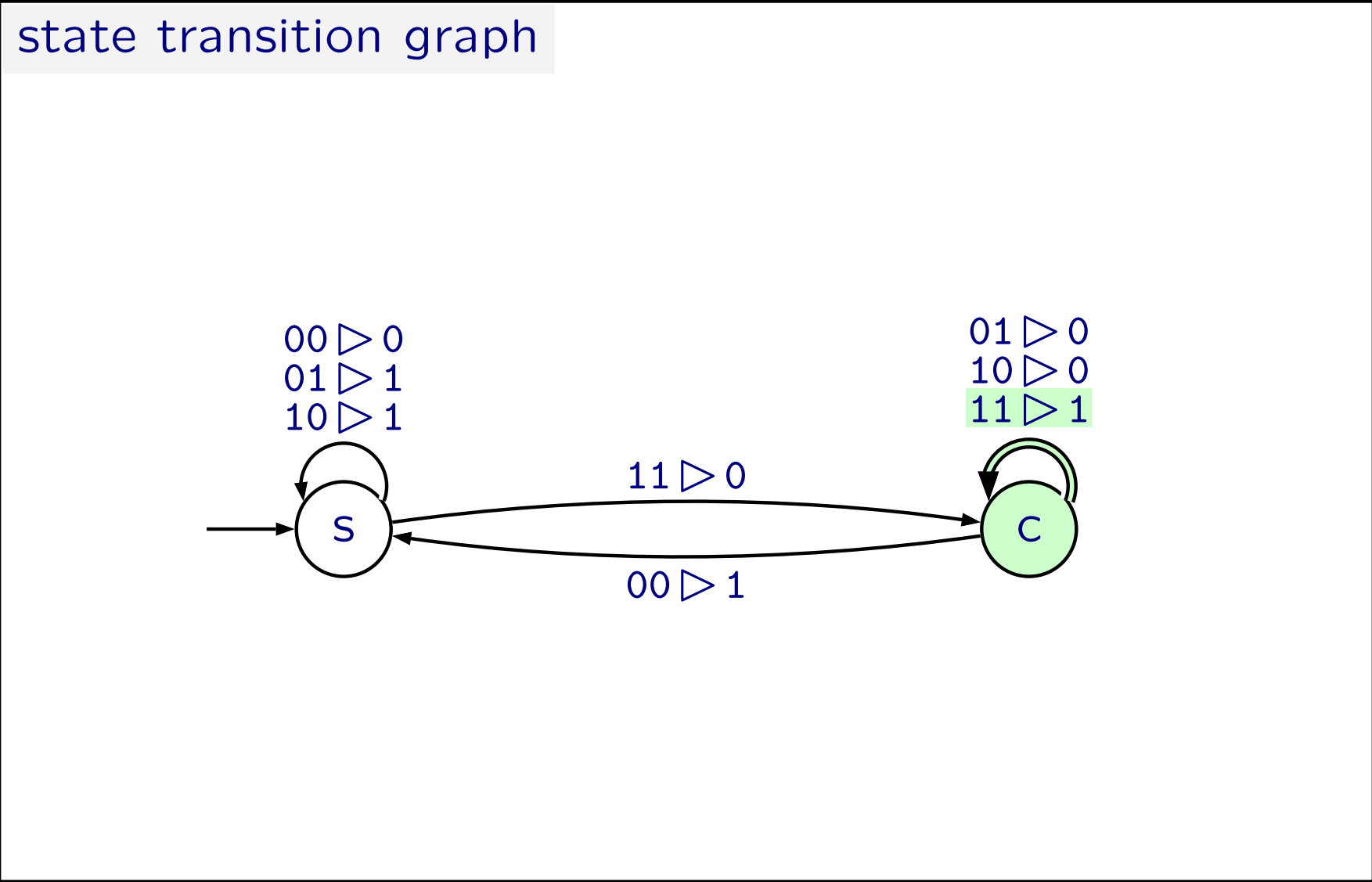

outp 0 1 0

one bit serial adder

input

00

10

11

11

01

00

state transition graph

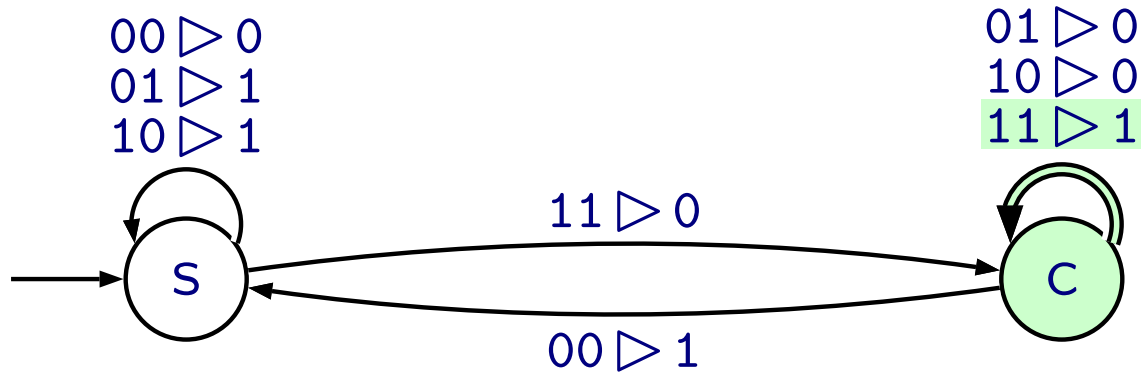

output

0

1

0

1

one bit serial adder

input 00 10 11 11 01 00

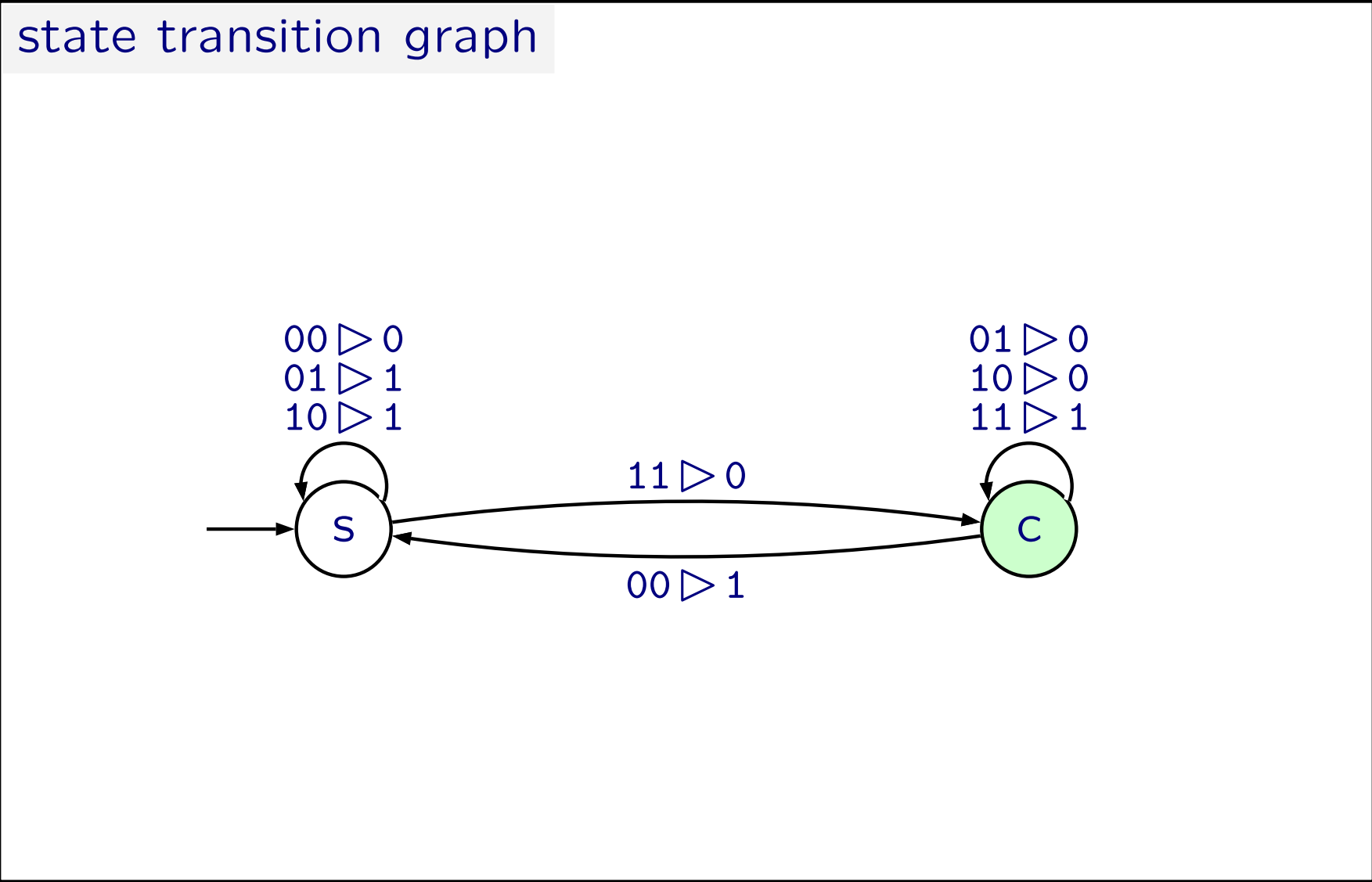

outp 0 1 0 1

one bit serial adder

input 00 10 11 11 01 00

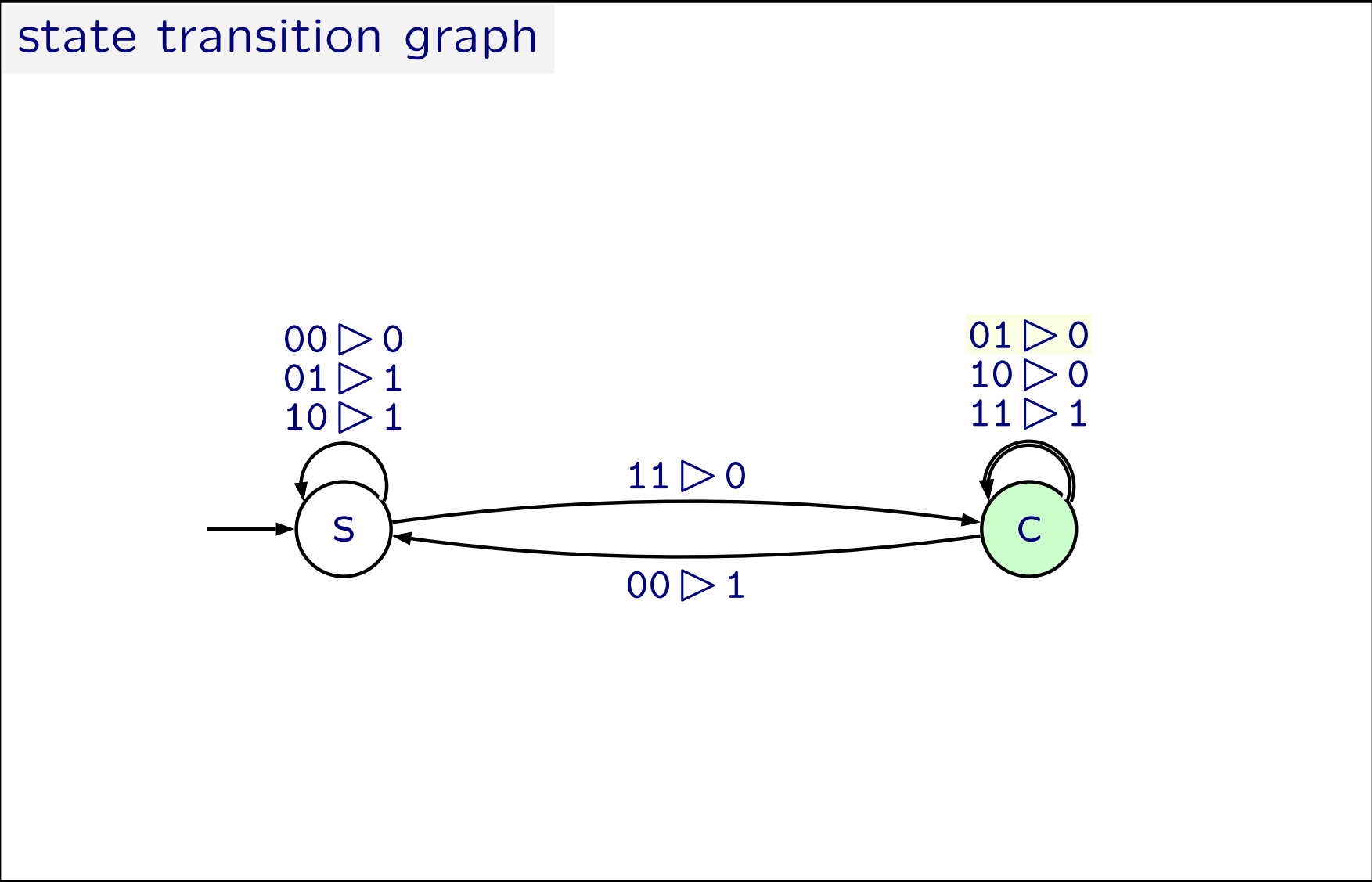

output 0 1 0 1

one bit serial adder

input

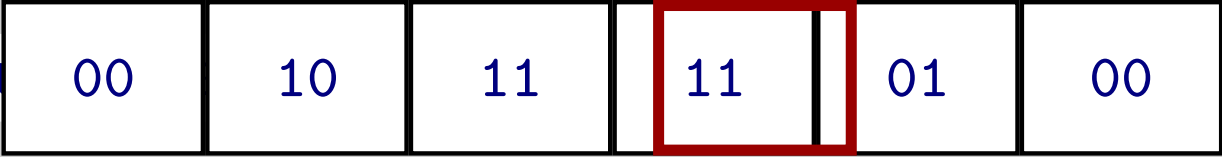

state transition graph

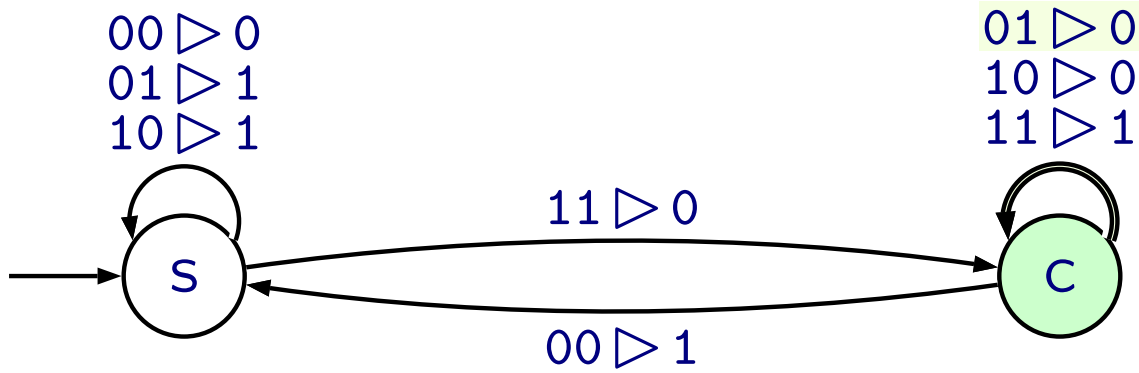

output



one bit serial adder

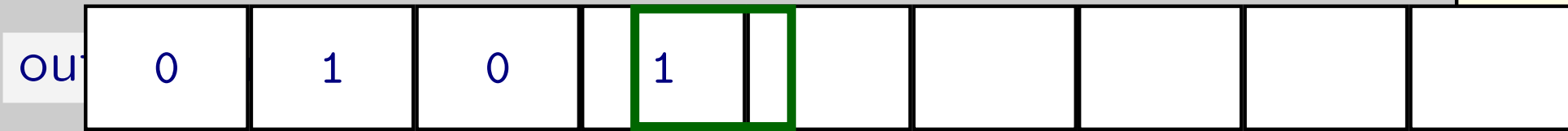
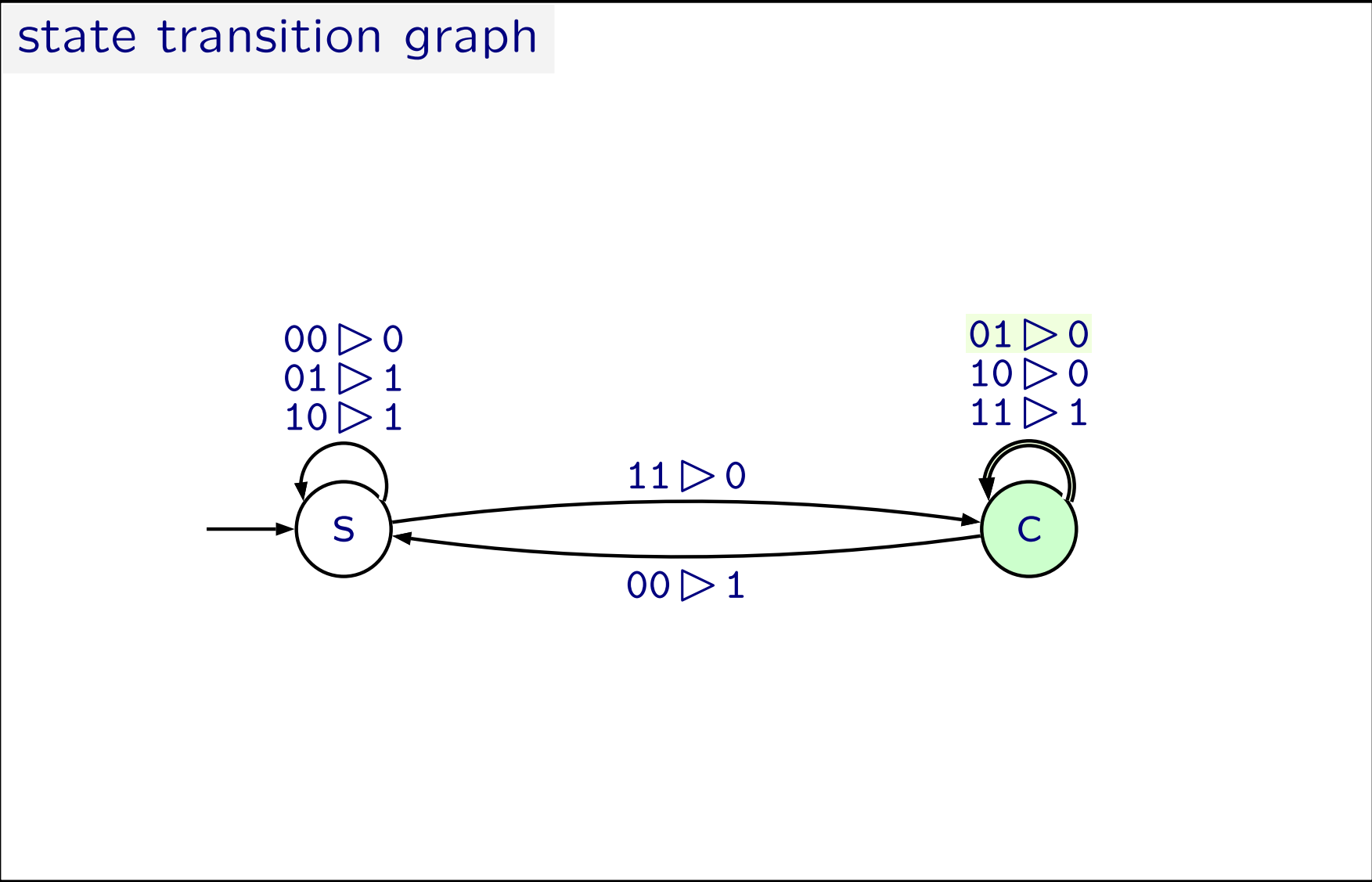
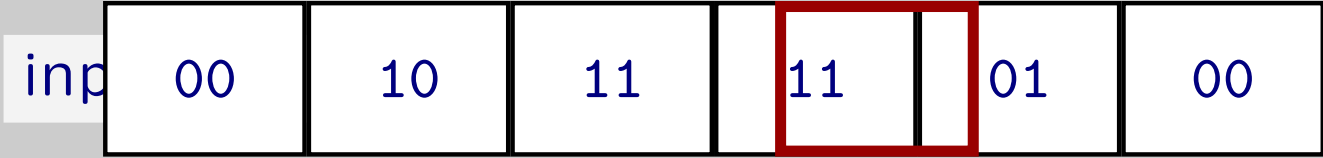

one bit serial adder

in 00 10 11 11 01 00

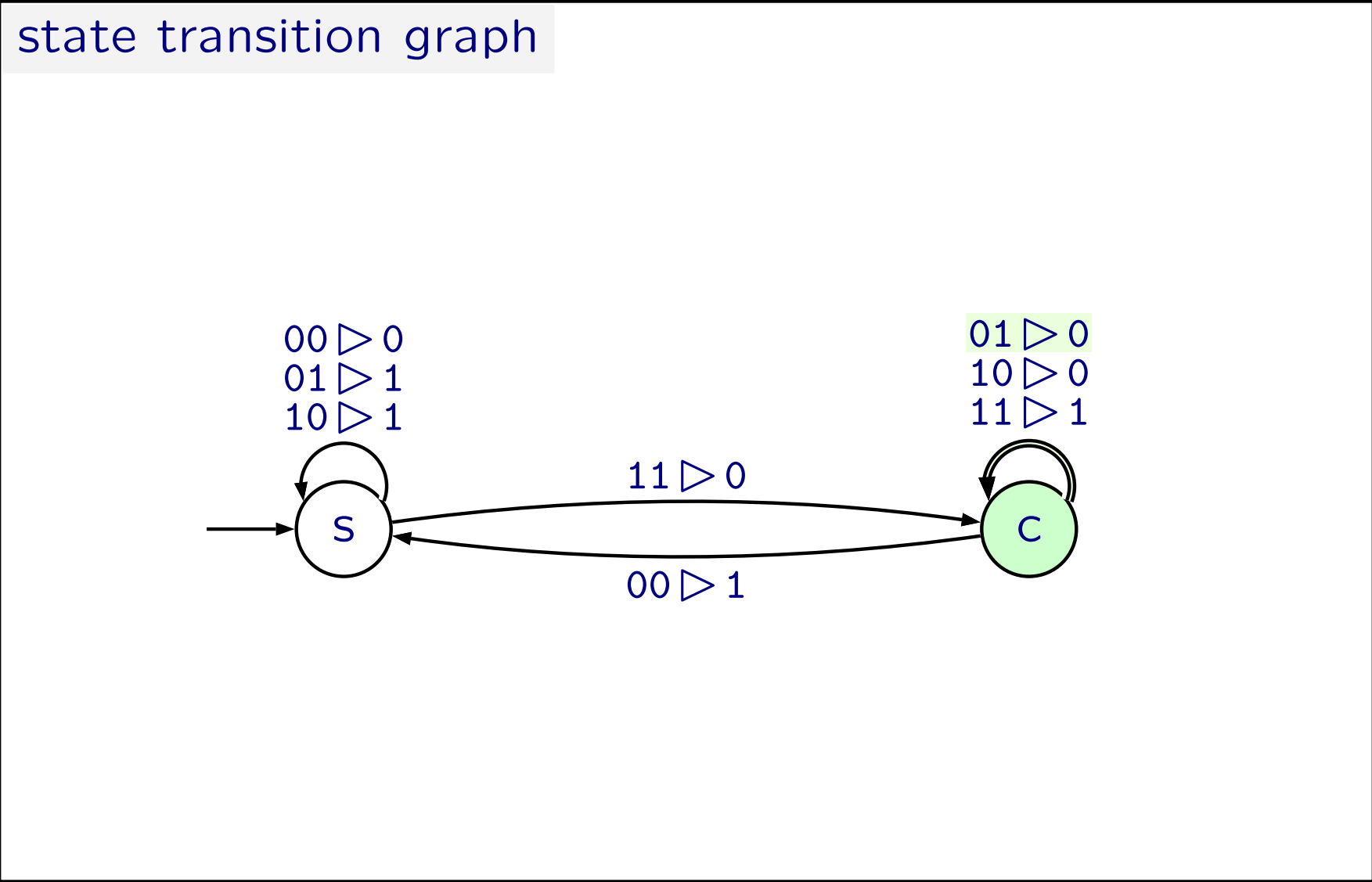

ou 0 1 0 1

one bit serial adder

in 00 10 11 11 01 00

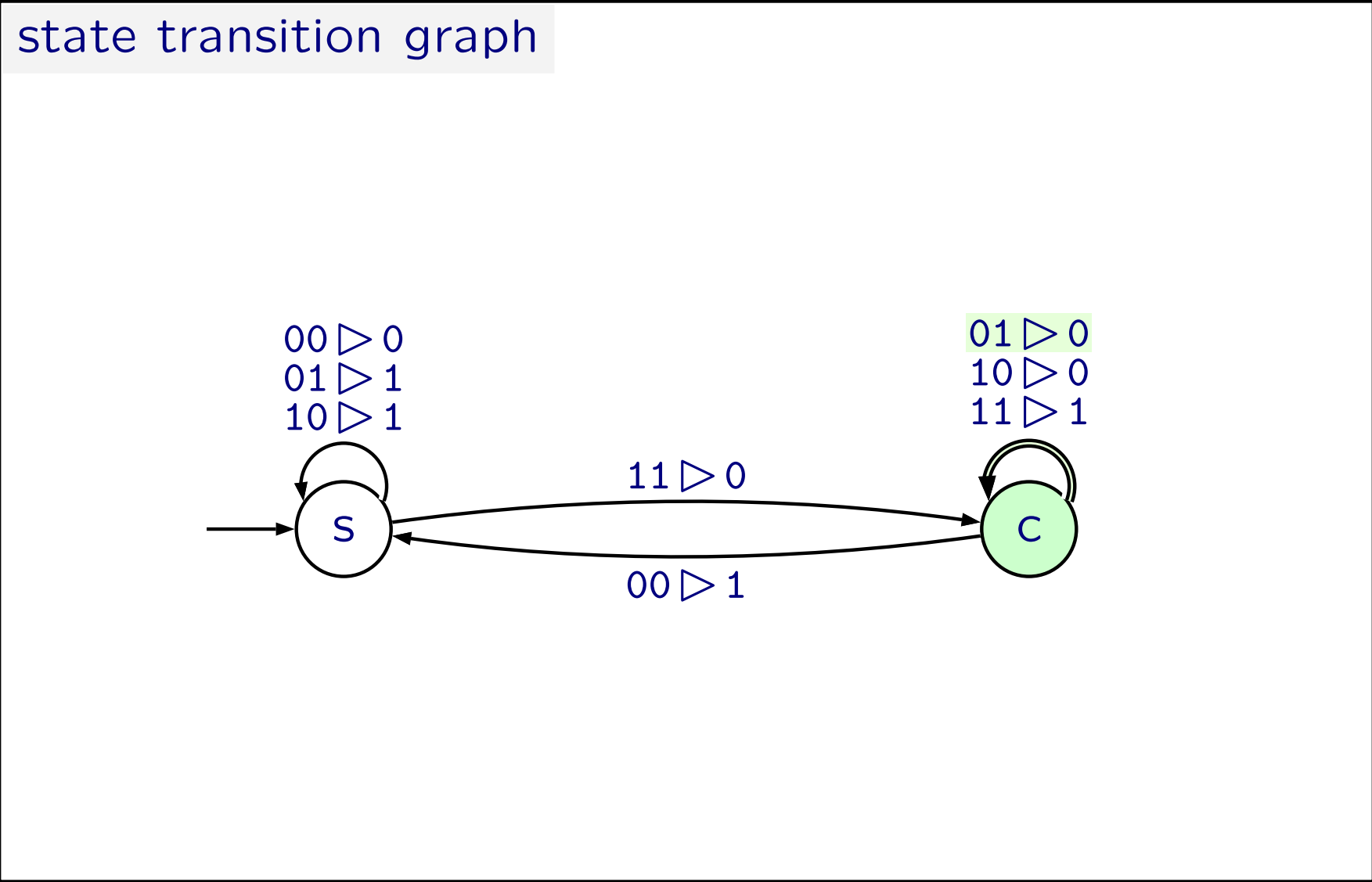

o 0 1 0 1

one bit serial adder

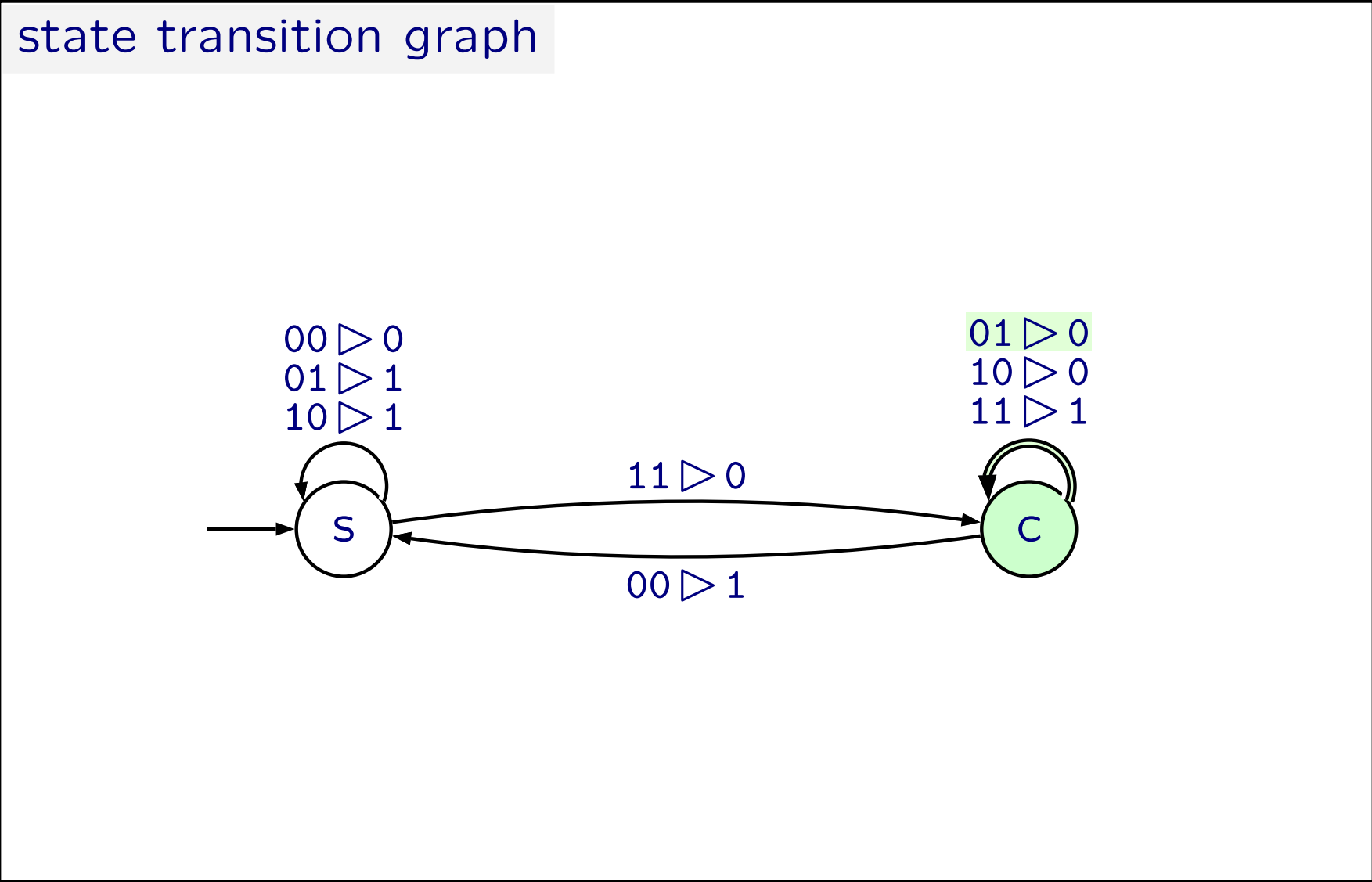
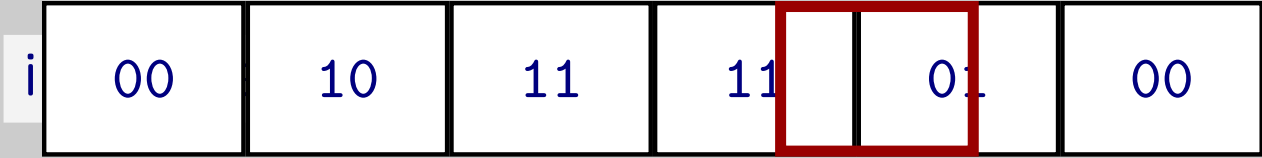

one bit serial adder

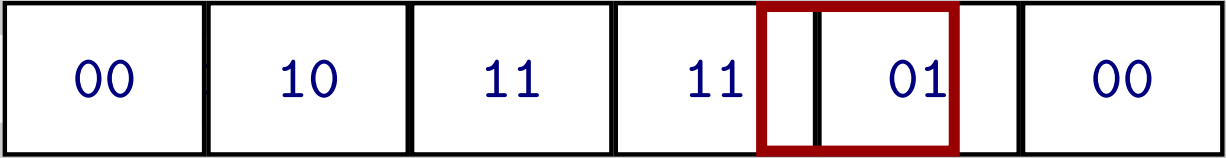

state transition graph

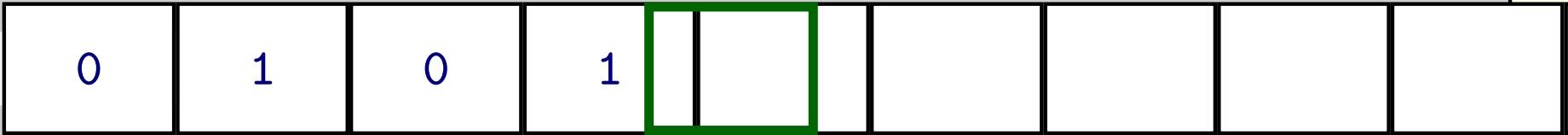
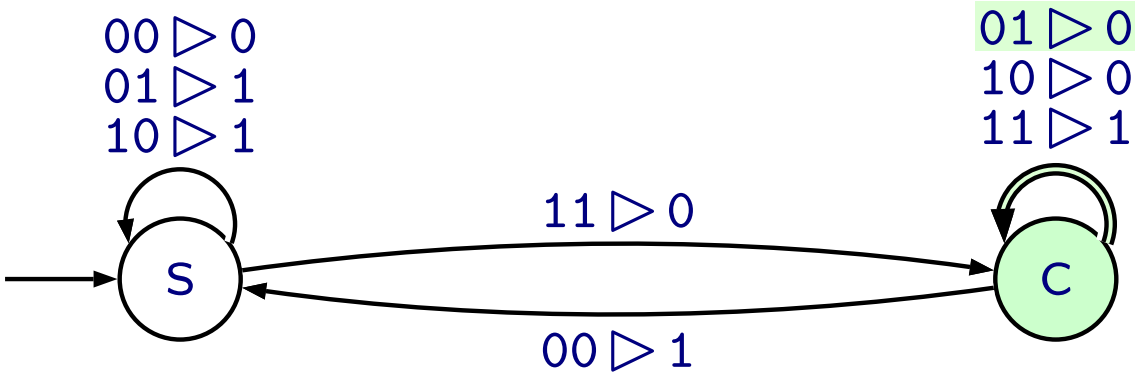

one bit serial adder

00	10	11	11	01	00
----	----	----	----	----	----

state transition graph

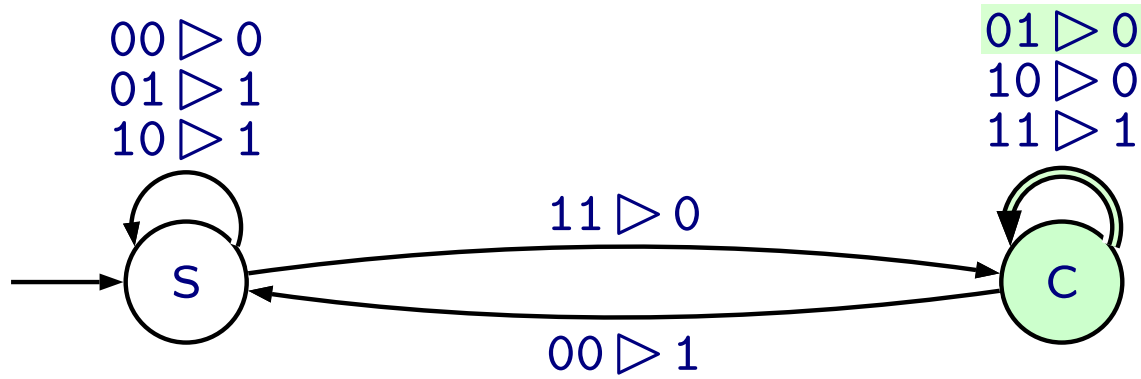

0	1	0	1						
---	---	---	---	--	--	--	--	--	--

one bit serial adder



state transition graph

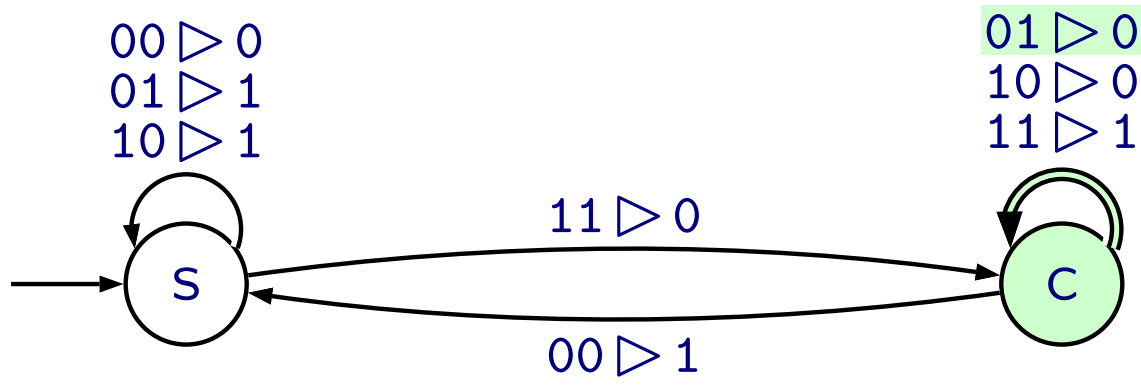

one bit serial adder

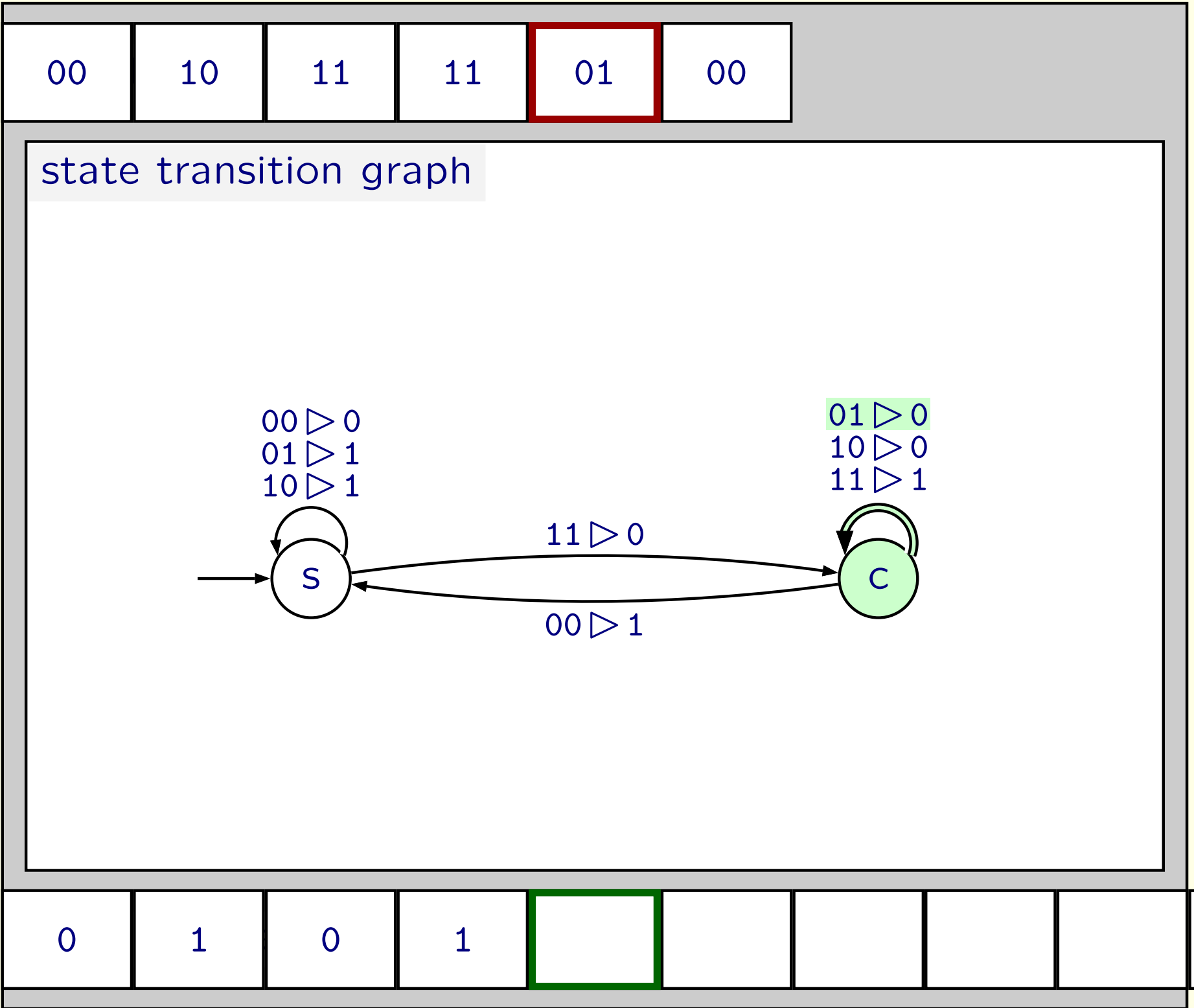

one bit serial adder

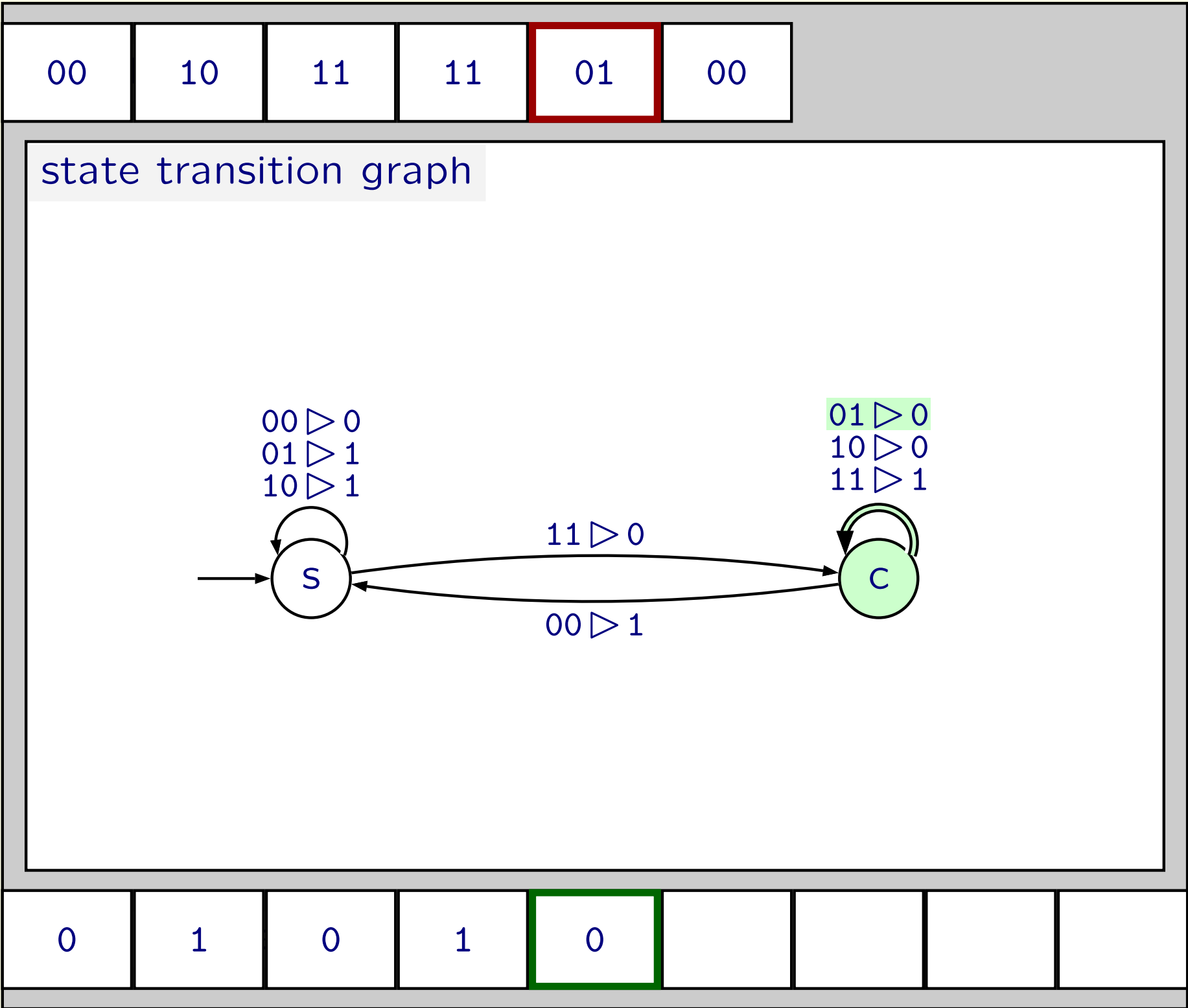

one bit serial adder

00

10

11

11

01

00

state transition graph

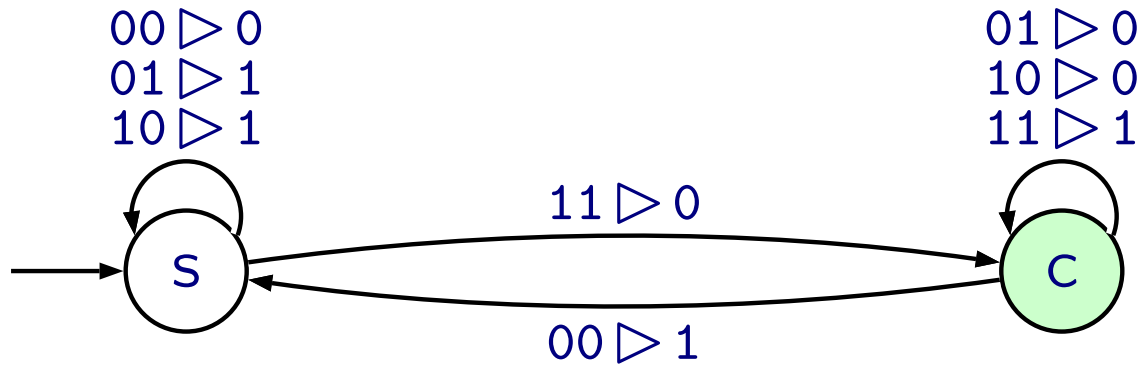

0

1

0

1

0

00

10

11

11

01

00

state transition graph

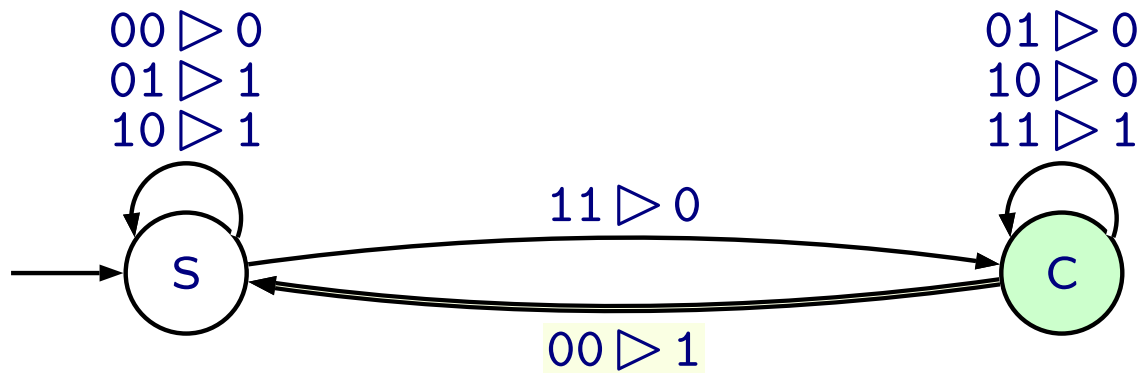

one bit serial adder

0

1

0

1

0

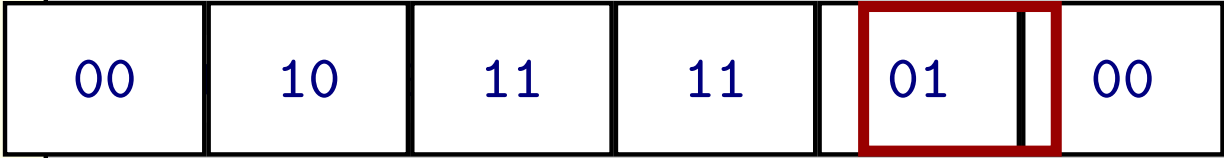

state transition graph

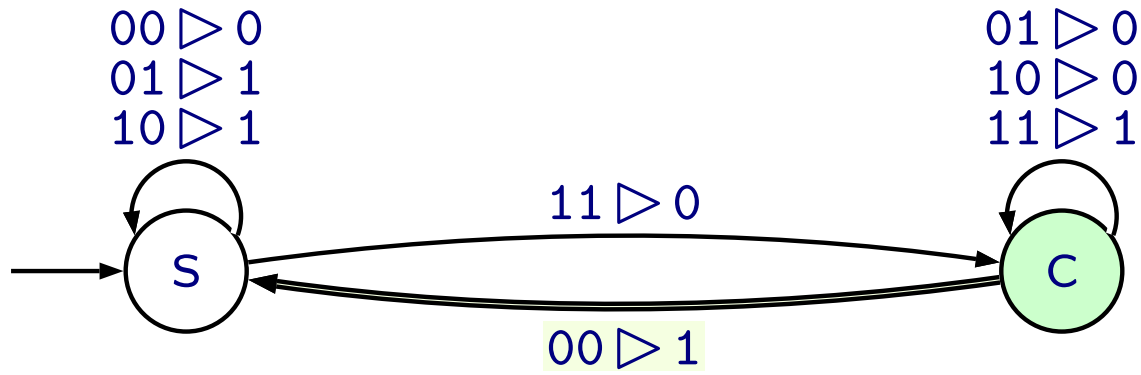

one bit serial adder

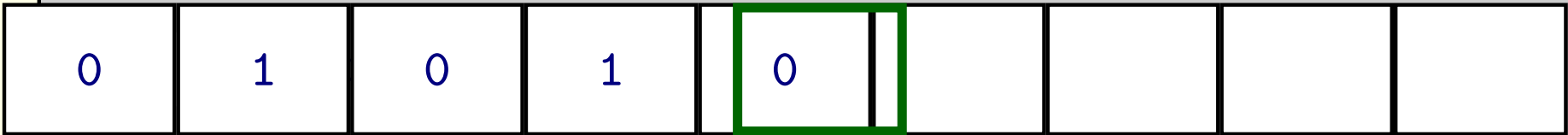

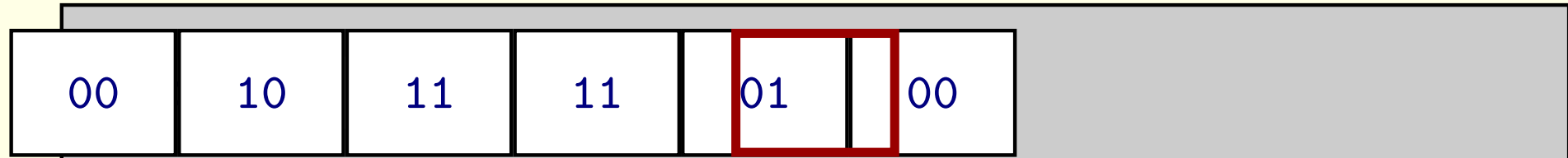

one bit serial adder

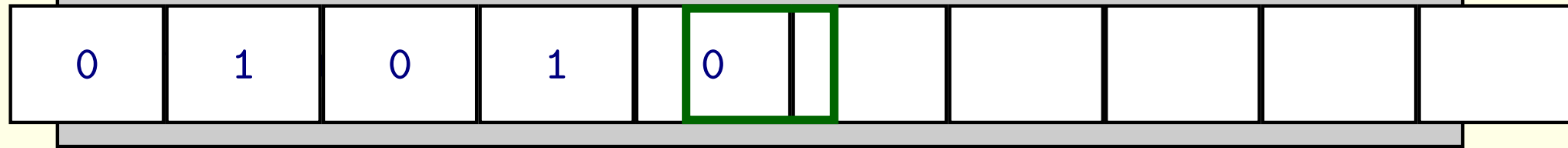
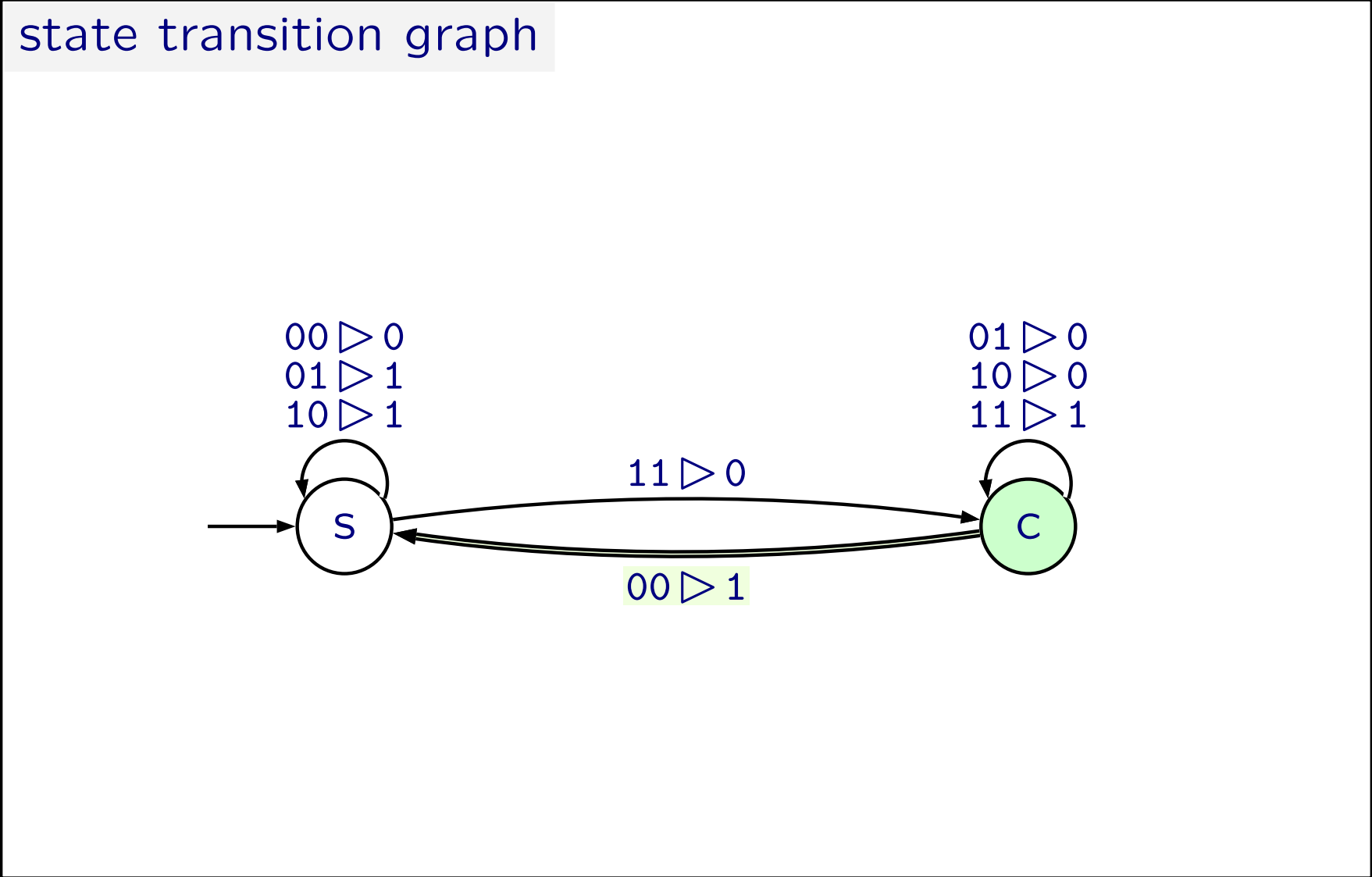



one bit serial adder

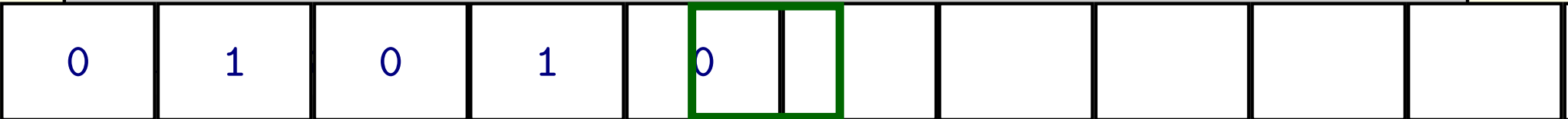
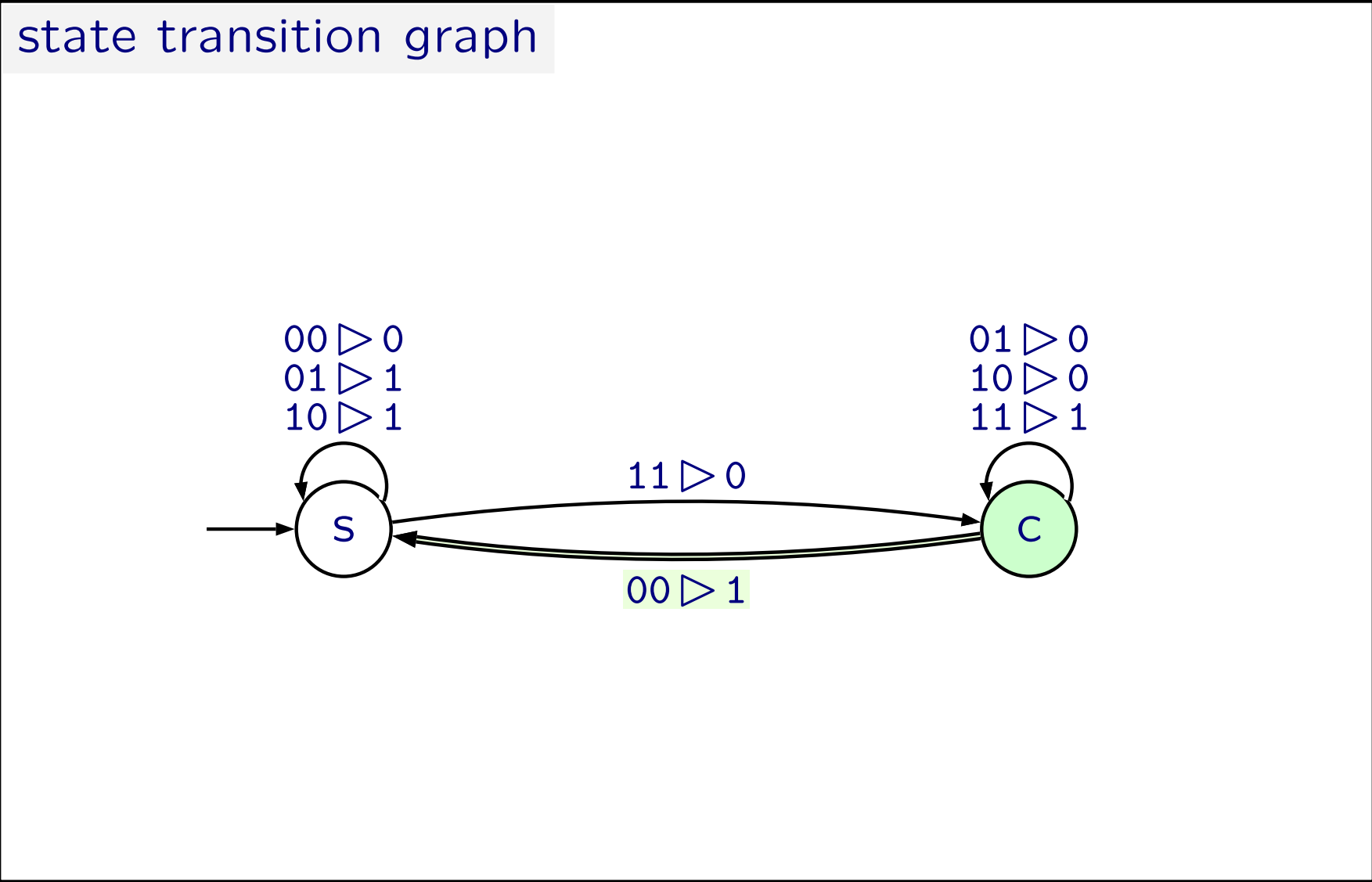

00 10 11 11 01 00

state transition graph

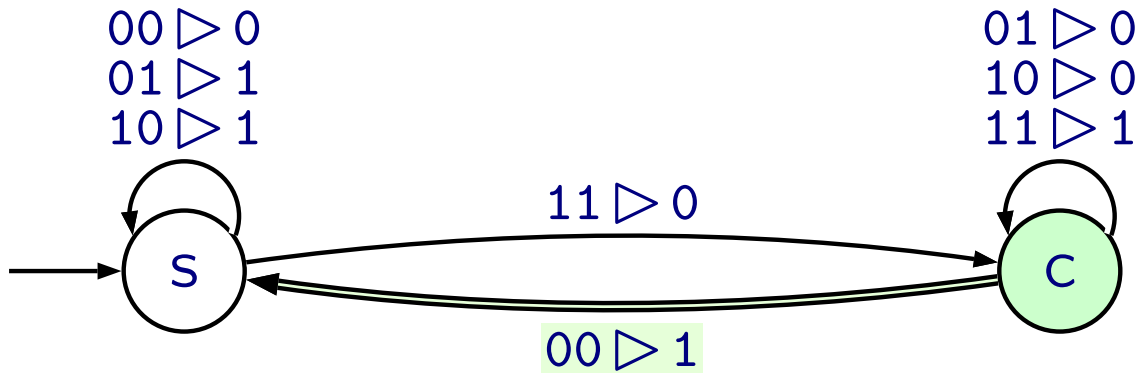

one bit serial adder

0 1 0 1 0 1

00

10

11

11

01

00

state transition graph

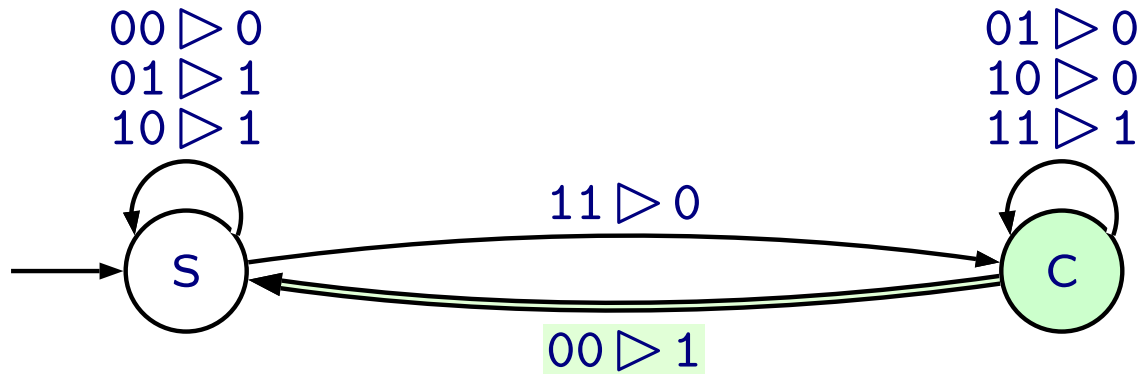

one bit serial adder

0

1

0

1

0

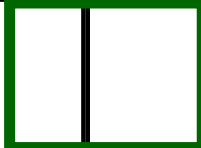

00

10

11

11

01

00

state transition graph

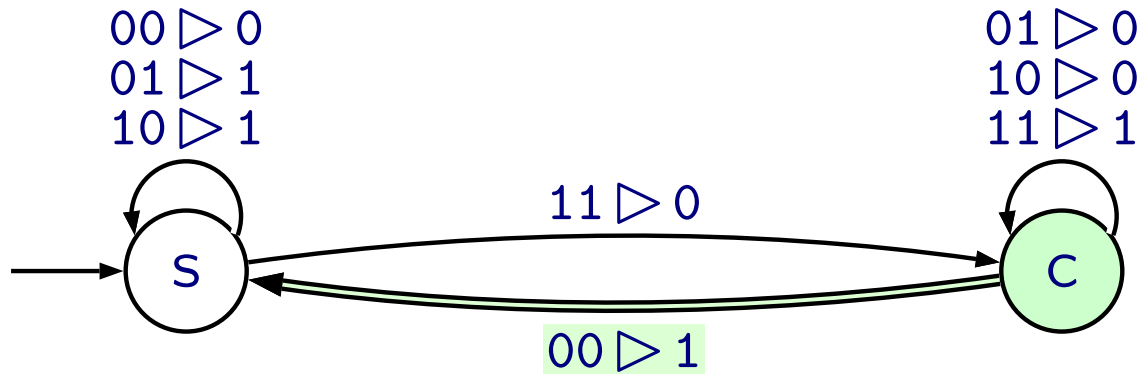

one bit serial adder

0

1

0

1

0

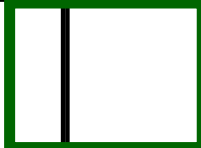

00

10

11

11

01

00

one bit serial adder

state transition graph

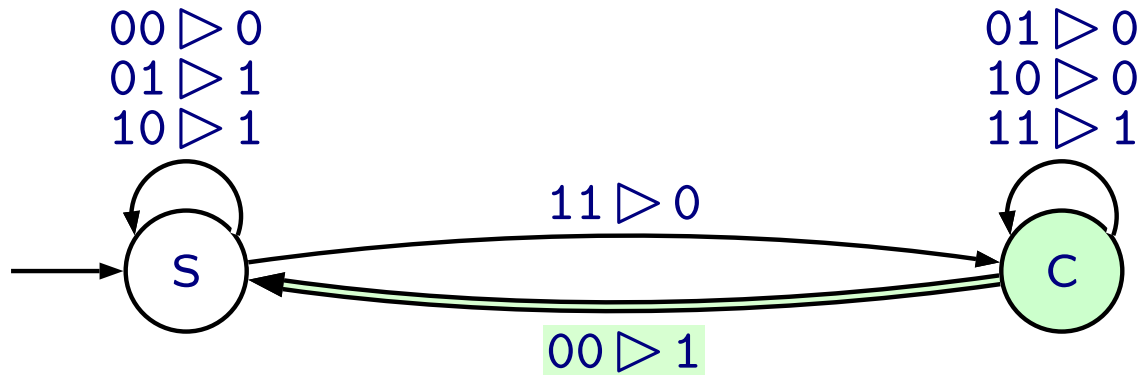

0

1

0

1

0

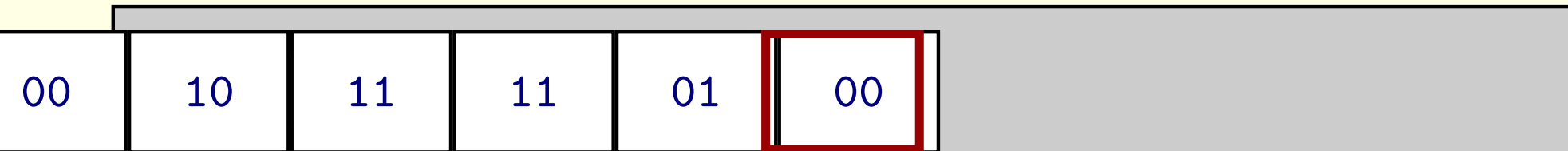

one bit serial adder

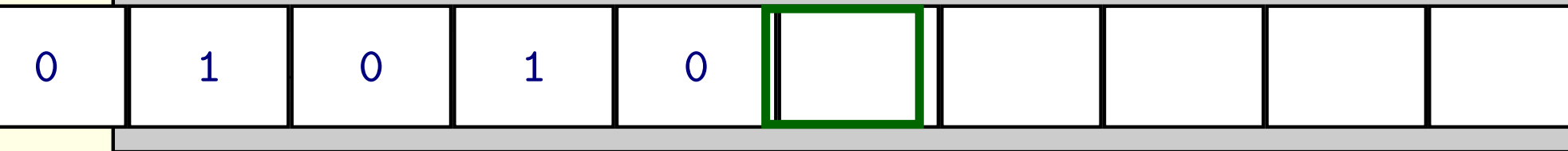
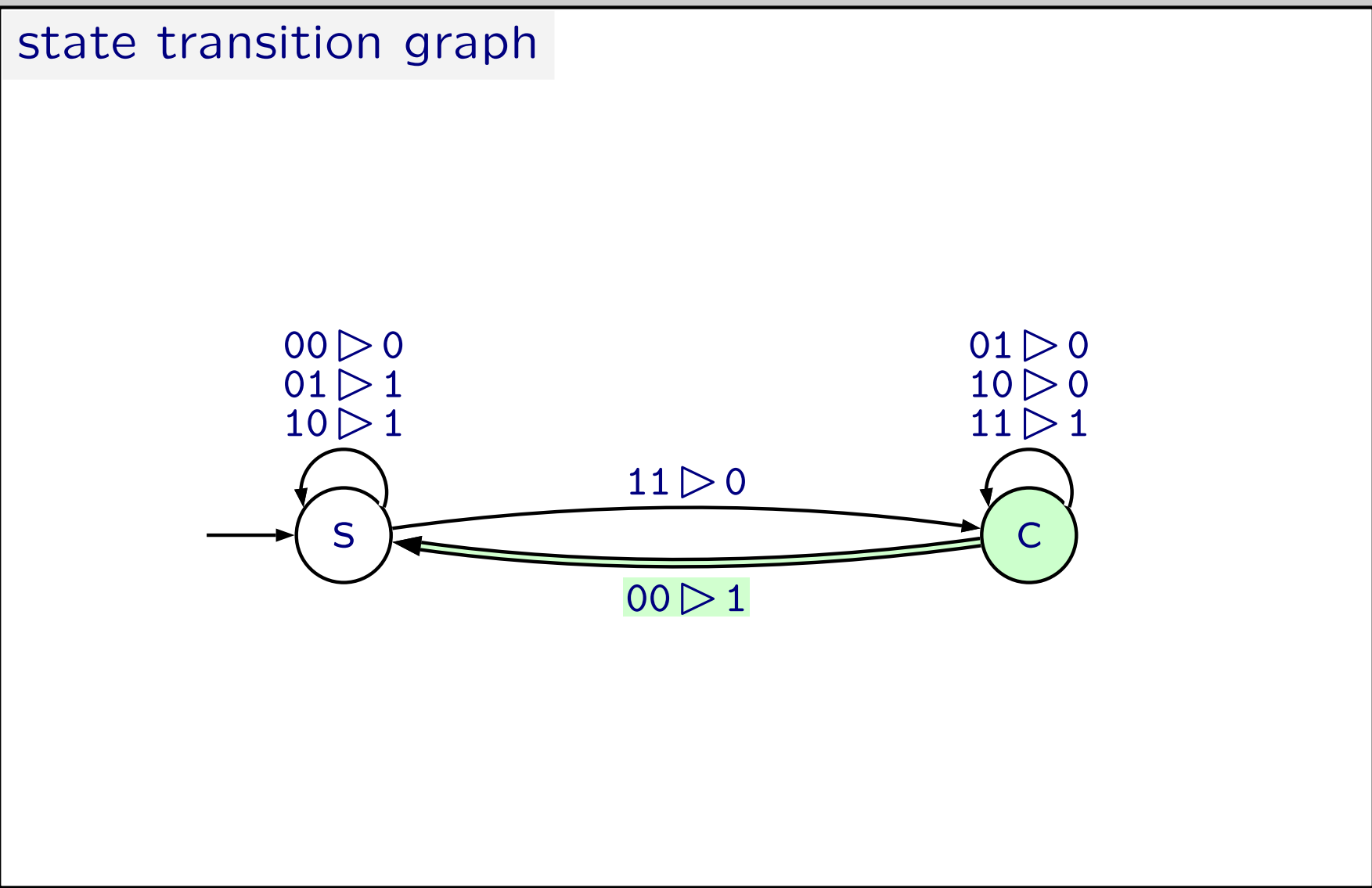

00

10

11

11

01

00

one bit serial adder

state transition graph

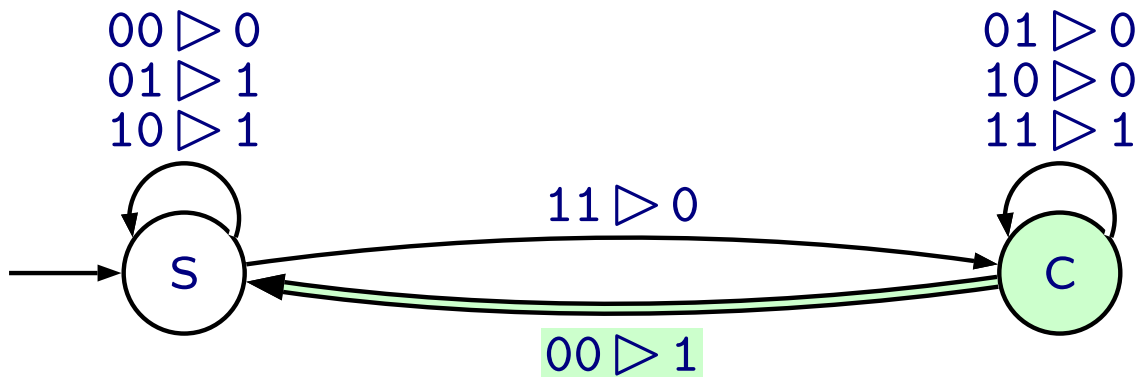

0

1

0

1

0

00

10

11

11

01

00

one bit serial adder

state transition graph

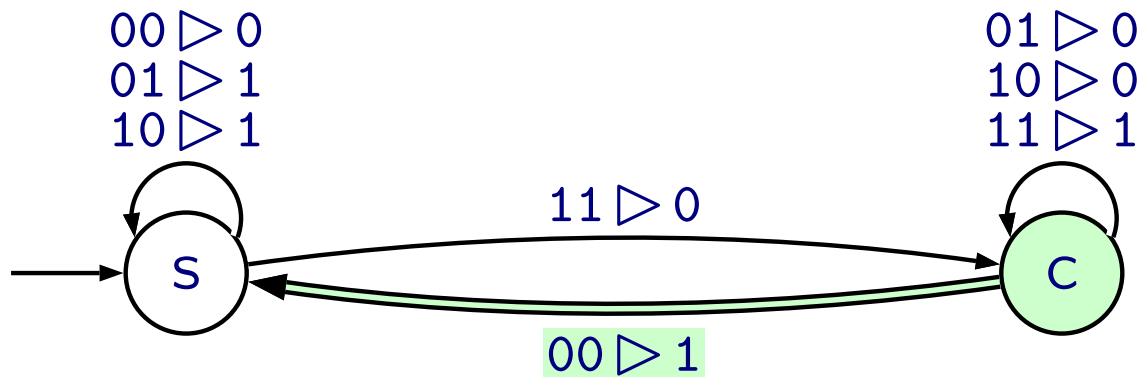

0

1

0

1

0

1

00

10

11

11

01

00

one bit serial adder

state transition graph

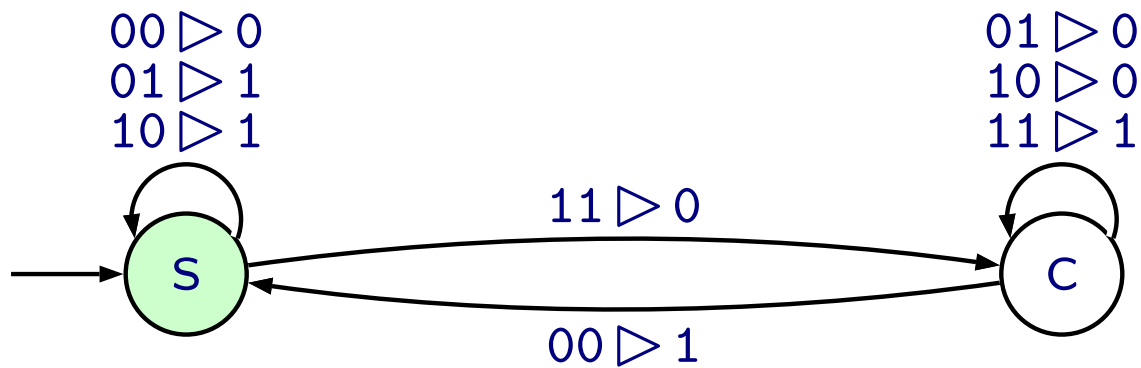

0

1

0

1

0

1